

Timer/Counter/ Analyzer

PM6680B, PM6681 & PM6681R

Operators Manual

All rights reserved. Reproduction in whole or in part is prohibited without written consent of the copyright owner.

TimeView is a trademark of Pendulum Instruments AB.

FLUKE is a trademark of Fluke Corporation.

TimeView uses the SPAWNO routines by Ralf Brown to minimize memory use while shelling to DOS and running other programs.

Pendulum Instrumen AB - Sweden - 2000

Table of Contents

Warranty Statement	I-VI	4 Measuring Functions	
1 Preparation for Use		Introduction to this Chapter	4-2
Preface	1-2	Selecting Function	4-2
Introduction	1-2	Frequency Measurements	4-3
Design Innovations	1-3	FREQ A	4-3
New fast SCPI Bus	1-5	FREQ C	4-3
Safety Instructions	1-6	PER A	4-4
Introduction	1-6	RATIO A/B	4-4
Safety precautions	1-6	BURST	4-4
Unpacking	1-8	Frequency Modulated Signals	4-8
Unpacking instructions	1-8	AM Signals	4-10
Installation	1-9	Theory of Measurement	4-11
Supply voltage	1-9	Time Measurements	4-14
Orientation and cooling	1-10	Introduction	4-14
Fold-down Support	1-11	TIME A-B	4-14
2 Using the controls		P WIDTH A	4-15
Basic Controls	2-2	RISE/FALL A	4-15
Input Controls	2-4	DUTY F A	4-15
Measurement Control Keys	2-6	Measurement Errors	4-16
Processing	2-8	Totalize	4-17
Display	2-9	Totalize General	4-17
Rear Panel	2-11	TOT A-B MAN	4-17
Default Settings (after PRESET)	2-13	TOT A MAN	4-18
3 Input Signal Conditioning		TOT A-B During a Preset Time	4-18
Input Amplifier	3-2	TOT A Start/Stop by B	4-19
How to Reduce or Ignore Noise and Interference	3-7	TOT A Gated by B	4-19
		TOT A Gated by B Accumulated During a Preset Time	4-19
		Phase	4-20
		What is Phase?	4-20
		Resolution	4-20
		Possible Errors	4-21
		Voltage	4-28
		V _{MAX} V _{MIN}	4-28

4822 872 20079
June 2000

V _{PP}	4-28
V _{rms}	4-29
Gated Voltage	4-29

5 Measurement Control

About This Chapter	5-2
Digit Blanking	5-5

Controlling Measurement Timing . 5-6

The Measurement Process	5-6
Arming Setup Time	5-13

Arming Examples . 5-14

Introduction to Arming Examples	5-14
#1 Measuring the First Burst Pulse	5-16
#2 Measuring the Second Burst Pulse ..	5-18
#3 Measuring the Third Burst Pulse	5-20
#4 Measuring the time between burst pulse #1 and #4	5-21
#5 Measuring Frequencies in Two-Tone Bursts	5-24
#6 Measure the Frequency in a Short RF-Burst	5-25
#7 Profiling	5-26

6 Process

Introduction	6-2
Averaging	6-2
Mathematics	6-3
Statistics	6-4

7 Auxiliary Functions

About this chapter	7-2
Auxiliary Menu	7-2

Auxiliary Codes . 7-11

8 TimeView for PM6681

Introduction	8-2
Installation	8-3
Software Installation	8-3
Hardware Installation	8-5
Configuring TimeView	8-6
Software installation (Windows NT)	8-7
The TimeView Screen	8-9
View	8-13
Help	8-16

Summary of Shortcut Keys	8-17
--------------------------------	------

Capturing Data. 8-18

Preparing a Measurement	8-18
Setting up the Timer/Counter	8-18
Capture	8-25

Analyzing Data. 8-30

Statistics	8-30
Fast Fourier Transform	8-32
Smoothing	8-37

Saving and Printing. 8-38

File	8-38
Print	8-40

9 Performance Check

General Information	9-2
Test Equipment	9-2
Front Panel Controls	9-3
Short Form Specification Test	9-7
Rear Input/Output	9-12
Measuring Functions	9-15
Check of HOLD OFF Function	9-16
Options	9-16

10 Preventive Maintenance

Calibration	10-2
Other Maintenance	10-3

11 Specifications

PM6680B 11-2

Measuring Functions	11-2
---------------------------	------

PM6681 11-2

Measuring Functions	11-2
Input Specifications	11-6
Input Specifications	11-6
Output Specifications	11-9
Output Specifications	11-9
Auxiliary Functions	11-10
Auxiliary Functions	11-10
Measurement Uncertainties	11-14
Measurement Uncertainties	11-14
Definitions of Random Uncertainty Terms	11-17
Definitions of Random Uncertainty Terms	11-17

Definitions of Systematic Uncertainty Terms	11-18
Definitions of Systematic Uncertainty Terms	11-18
LSD Displayed.	11-19
LSD Displayed.	11-19
General Specifications.	11-20
General Specifications.	11-20
GPIB Interface.	11-22
GPIB Interface.	11-22
TimeView.	11-23
TimeView.	11-23
RF Input Options	11-24
RF Input Options	11-24
Timebase Options	11-25
Ordering Information	11-27
Ordering Information	11-27

12 Appendix

Appendix 1, Error Messages	12-2
----------------------------	------

13 Index

14 Service

Sales and Service office	14-2
--------------------------	------

DECLARATION OF CONFORMITY

for

Fluke
Timer / Counter / Analyzer
PM6680B / PM6681 / PM6681R

Fluke Precision Measurement Ltd.
Norwich Airport Industrial Estate
Norwich
Norfolk NR6 6JB
UK

Statement of Conformity

Based on test results using appropriate standards, the product is in conformity with
Electromagnetic Compatibility Directive 89/336/EEC
Low Voltage Directive 73/23/EEC

Sample tests

Standards used:

EN 61010-1 (1993) CAT II
Safety Requirements for Electronic Measuring Apparatus

EN 55011 (1991) Group 1, Class B
Limits and methods of measurement of radio disturbance characteristics of industrial, scientific
and medical radio-frequency equipment

EN 50082-2
Electromagnetic Compatibility Generic Immunity Standard:
IEC801-2, -3, -4

The tests have been performed in a typical configuration.

This Conformity is indicated by the symbol **CE**, i.e. "Conformité européenne".

Chapter 1

Preparation for Use

Preface

Introduction

Your Timer/Counter/Analyzer is designed to bring you a new dimension to bench-top and system counting. It offers significantly increased performance compared to traditional Timer/Counters. The PM6680B offers the following advantages:

- 10 digits of frequency resolution per second and 250 ps resolution, as a result of high-resolution interpolating reciprocal counting
- high frequency input options of 1.3, 2.7, 4.2 OR 4.5 GHz
- High-stability oven oscillators options
- Optional GPIB (SCPI) interface with up to 2 k measurements/s to internal memory

In addition to the above the PM6681 offers the following advantages:

- 11 digits of frequency resolution per second and 50 ps time resolution
- Integrated high performance GPIB interface using SCPI commands
- Timestamping; the counter records exactly when a measurement is made
- A high measurement rate of up to 8k readings/s to internal memory

- A version, PM6681R, with built-in Rubidium timebase (“atomic clock”)

New powerful and versatile functions

A unique performance feature in your new instrument is the complete arming possibilities, which allow you to characterize virtually any type of complex signal concerning frequency and time.

For instance, you can insert a delay between the external arming condition and the actual arming of the counter. You can set this delay to a preset time or a number of trigger events, whereby you can for example measure the width of pulse No. 17 after the arming pulse. Read more about Arming in Chapter 5, “Measurement Control”.

The counter has a multitude of measuring functions such as phase, duty factor, rise/fall-time, peak voltage, and six totalizing modes. The six totalizing modes include simultaneous up/down count (TOT A-B) and the ability to totalize during a preset time after a manual start. The counter can perform all measuring functions except rise/fall time on both main inputs (A & B), and all functions

except phase, rise/fall time and peak voltage on input E (arming input).

By using the built-in mathematics and statistics functions, the instrument can process the measurement results on your benchtop, without the need for a controller. Math functions include inversion, $\frac{1}{x}$, and frequency difference measurements ($X_N - X_{N-1}$). Statistics functions include Max, Min, Mean and Standard Deviation.

No mistakes

You will soon find that your new instrument is *a delight to operate*. One example is the backlit LCD that shows you measurement results, setting status, and operator messages. The AUTO function triggers automatically on any input wave form. A bus-learn mode simplifies GPIB programming. With bus-learn mode, manual counter settings can be transferred to the controller for later reprogramming. There is no need to learn code and syntax for each individual counter setting if you are an occasional bus user.

The ultra-stable PM6681R: Timer/Counter/Analyzer + Frequency Reference

The PM6681R is an extremely stable version of the PM6681. It contains an atomic resonance-controlled timebase (Rubidium) that gives a new meaning to 10-12 digit measurements. To distribute the stable 10 MHz reference to other instruments, the PM6681R has six amplified reference outputs (5 x 10 MHz and 1 x 5 MHz), compared to one 10 MHz output in the standard version.

The warm-up time is only 10 minutes to get as close as 4×10^{-10} from the final timebase frequency. This makes it unnecessary to keep the timebase switched on during transport.

Design Innovations

State of the art technology gives durable use

These counters are designed for quality and durability. The design is highly integrated. The digital counting circuitry consists of just two custom-developed VLSI-ASICs and a 16-bit microcontroller. The high integration and low component count reduces power consumption and results in an MTBF of 30,000 hours.

Modern surface-mount technology ensures high production quality. A rugged mechanical construction, including a metal cabinet that withstands mechanical shocks and protects against EMI, is also a valuable feature.

High resolution

The use of *reciprocal interpolating counting* in this new counter results in excellent relative resolution: 10 digits in one second for *all* frequencies.



The measurement is synchronized with the input cycles instead of the timebase. Simultaneously with the normal “digital” counting, the counter makes analog measurements of the time between the start/stop trigger events and the next following clock pulse. This is done in two identical circuits by charging an integrating capacitor with a constant current, starting at the trigger event. Charging is stopped at the leading edge of the first following clock pulse. The stored charge in the integrating capacitor represents the time difference between the start trigger event and the leading edge of the first following clock pulse.

When the “digital” part of the measurement is ready, the stored charges in both capacitors are measured. The capacitors are discharged with

a constant current, which is only 1/400th of the charging current, which means that the discharge time will be 400 times the charging time. This 400-fold stretched time is digitally measured by the counter itself, with adequate resolution.

The counter's microcomputer calculates the result after completing all measurements, i.e., the digital time measurement and the two interpolation measurements.

The result is that the basic "digital resolution" of ± 1 clock pulse (100 ns for the PM6680B and 10 ns for the PM6681) is reduced to 250 ps and 50 ps resp.

Since the measurement is synchronized with the input signal, the resolution for frequency measurements is very high and independent of frequency.

The counters have 10 display digits to ensure that the display does not restrict the resolution display. They also have an overflow function that lets you see digit 11 and 12.

New fast SCPI Bus

These counters are not only extremely powerful and versatile bench-top instruments, they also feature extraordinary IEEE-488 bus properties.

To ensure compatibility now and in the future, they incorporate the latest IEEE-488.2 bus standard and the internationally standardized SCPI Command Set (Standard Commands for Programmable Instruments).

The bus transfer rate of the PM6680B is up to 125 triggered measurements/s over the IEEE-488 bus, and 2,000 measurements per second to internal memory. The PM6681 is even faster with a bus transfer rate of up to 250 triggered measurements/s over the IEEE-488 bus, and 8,000 measurements per second to internal memory.

This very high measurement rate makes new measurements possible. For example, you can perform *jitter analysis* on several thousands of pulse width measurements and capture them in a second.

Together with the IEEE-488 interfaces you get an extensive programming manual that helps you understand SCPI and counter programming.

An analog recorder output is incorporated into the IEEE-488 interface. This output provides an analog signal proportional to the value of any three consecutive display digits. The output can be used for recordings of measurements on a strip-chart recorder or as a feedback signal to an analog control system.

The counter is easy to use in IEEE-488 bus environments. A built-in *bus-learn* mode enables you to make all counter settings manually and transfer them to the controller. The response can later be used to reprogram the

counter to the same settings. This eliminates the need for the occasional user to learn all individual programming codes.

Complete (manually set) counter settings can also be stored in 19 internal memory locations and can easily be recalled on a later occasion.

Another user-friendly feature is *macro-programming*. You can define your own mnemonics and define group settings for complex measurements, then reduce them to one macro command.

Safety Instructions

Introduction

Read this page carefully before you install and use the instrument.

This instrument has been designed and tested according to safety Class 1 requirements of EN61010-1 (1993) CAT II and CAN/CSA-C22.2 number 1010.1-92, and has been supplied in a safe condition. The user of this instrument must have the required knowledge of it. This knowledge can be gained by thoroughly studying this manual.

This instrument is designed to be used by trained personnel only. Removing the cover for repair, maintenance, and adjustment of the instrument must be done by qualified personnel who are aware of the hazards involved.



Figure 1-1 *Do not overlook the safety instructions!*

Safety precautions

To ensure the correct and safe operation of this instrument, it is essential that you follow generally accepted safety procedures in addition to the safety precautions specified in this manual.

Caution and warning statements

CAUTION: Shows where incorrect procedures can cause damage to, or destruction of equipment or other property.

WARNING: Shows a potential danger that requires correct procedures or practices to prevent personal injury.

Symbols



Shows where the protective ground terminal is connected inside the instrument. **Never** remove or loosen this screw.



Indicates that the operator should consult the manual.

One such symbol is printed on the instrument, below the A input. It points out that the damage level for the input voltage decreases from 350V_p to 12V_{rms} when you switch the input impedance from 1 M Ω to 50 Ω .

If in doubt about safety

Whenever you suspect that it is unsafe to use the instrument, you must make it inoperative by doing the following:

- Disconnecting the line cord
- Clearly marking the instrument to prevent its further operation
- Informing your local Fluke Service Center.

For example, the instrument is likely to be unsafe if it is visibly damaged.

Disposal of hazardous materials

WARNING: Disposal of lithium batteries requires special attention. Do not expose the batteries to heat or put them under extensive pressure. These measures may cause the batteries to explode.

The counter uses a lithium battery (See Figure 1-2) to power a backup RAM. Return used batteries to the vendor for recycling.

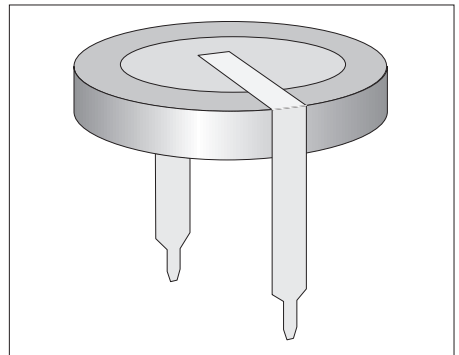

Figure 1-2 A lithium battery in the counter ensures that all settings are saved even when the power is turned off.

Unpacking

Unpacking instructions

Check that the shipment is complete and that no damage has occurred during transportation. If the contents are incomplete or damaged, file a claim with the carrier immediately. Also notify your local Fluke sales or service office in case repair or replacement may be required.

Check list

The shipment should contain the following:

- The Timer/Counter/Analyzer
- Line cord
- This Operators Manual
- Getting Started Manual
- Programming Manual*
- Options you ordered should already be installed, except the rack mount kit. See “Identification” below.
- N-to-BNC Adapter, if you ordered a HF input option of 2.7 Ghz or higher
- Certificate of Calibration

* Standardly included in PM6681 and with all PM6680B that are ordered with GPIB.

Identification

Options installed inside the cover are identified on the rear panel according to the list below. The rack mount kit, if ordered, must be assembled using the instructions on page 1-11.

- PM9621: 1.3 GHz input
- PM9624: 2.7 GHz input
- PM9625: 4.5 GHz input
- PM9625B: 4.2 GHz input
- PM9626: GPIB (PM6680B)
- PM9678: TCXO timebase 1×10^{-7} /month
- PM9691: OCXO timebase 1×10^{-8} /month
- PM9692: OCXO timebase 3×10^{-9} /month
- PM9697: 1, 2, 5MHz external reference frequency multiplier (PM6680B)
- PM9611/80: Rear panel inputs for input A, B, and C.

Installation

Supply voltage

Setting

The Timer/Counter/Analyzer may be connected to any AC supply with a voltage rating of 90 to 265 V_{rms}, 45 to 440 Hz. The counter automatically adjusts itself to the input line voltage.

Fuse

A 1.6A/250V slow-blow fuse is placed inside the counter. This fuse rating is used for the full voltage range.



Figure 1-3 1.6AT 5x20mm fuse

CAUTION: If this fuse is blown, it is likely that the power supply is badly damaged. Do not replace the fuse. Send the counter to the local Fluke Service Center.

Grounding

Grounding faults in the line voltage supply will make any instrument connected to it dangerous. Before connecting any unit to the power line, you must make sure that the protective ground functions correctly. Only then can a unit be connected to the power line and only by using a three-wire line cord. No other method of grounding is permitted. Extension cords must always have a protective ground conductor.



WARNING: If a unit is moved from a cold to a warm environment, condensation may cause a shock hazard. Ensure, therefore, that the grounding requirements are strictly met.

WARNING: Never interrupt the grounding cord. Any interruption of the protective ground connection inside or outside the instrument or disconnection of the protective ground terminal is likely to make the instrument dangerous.

Orientation and cooling

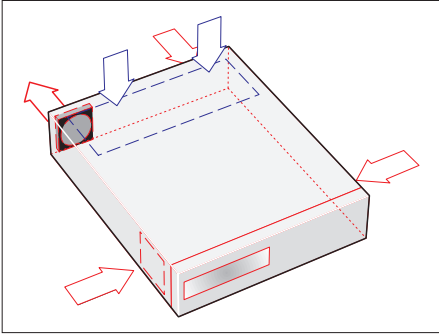

Figure 1-4 Air flow through the PM6681/PM6681R.

The counter can be operated in any position desired. Make sure that the air flow through the ventilation slots are not obstructed.

Leave 5 centimeters (2 inches) of space around the PM6680B.

The PM6681/PM6681R has a fan, so the space can be reduced to 1 centimeter ($\frac{1}{2}$ inch).

CAUTION: Never cover the ventilation slots at the right or left side. If the slots are covered, the counter will overheat.

The PM6681/81R fan control

The microcontroller uses the fan to adjust the temperature inside the counter so that it is as close as possible to the temperature when the last calibration was done. This regulation starts 45 minutes after power-on.

Fold-down Support

For bench-top use, a fold-down support is available for use underneath the counter. This support can also be used as a handle to carry the instrument.

Rack mount (accessory)

If you have ordered a handle kit or a rack

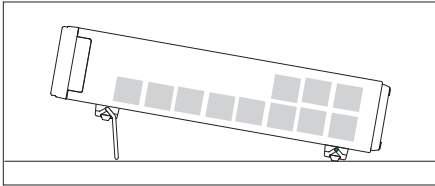

Figure 1-5 *Fold-down support for comfortable bench-top use.*

mount kit for your counter, it has to be assembled after delivery of the counter.

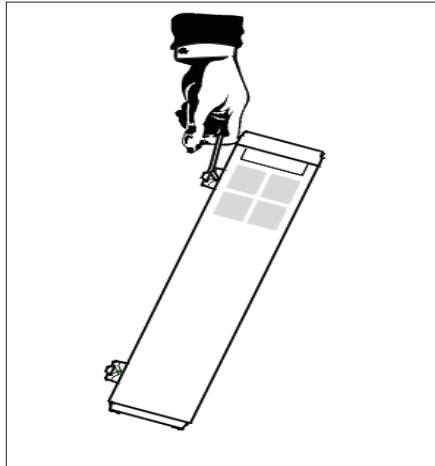

Figure 1-6 *Use the support to carry the counter.*

■ Rack mount adapter

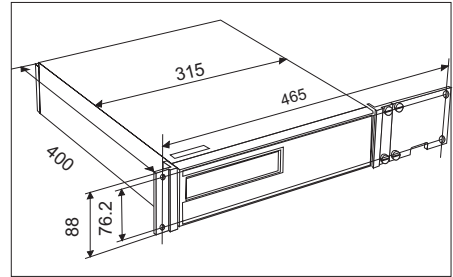

Figure 1-7 *Dimensions for rack-mounting hardware.*

The **rack mount kit**, PM9622, consists of the following:

- 2 brackets, (short, left; long, right)
- 4 screws, M5 x 8
- 4 screws, M6 x 8

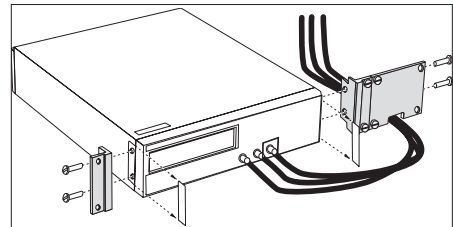

Figure 1-8 *Fitting the rack mount brackets on the counter.*

Preparation for Use

To assemble the rack mount kit, do the following:

WARNING: Do not perform any internal service or adjustment of this instrument unless you are qualified to do so.

WARNING: When you remove the cover you will expose live parts and accessible terminals which can cause death.

WARNING: Although the power switch is in the off position, line voltage is present on the printed circuit board. Use extreme caution.

WARNING: Capacitors inside the instrument can hold their charge even if the instrument has been separated from all voltage sources.

- Make sure the power cord is disconnected from the counter.
- Turn the counter upside down.
- Loosen the two screws (A) at the bottom and the two screws (B) in the rear feet.
- Grip the front panel and gently push at the rear.
- Pull the counter out of the cover.

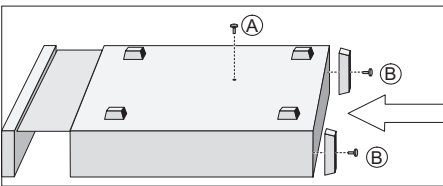

Figure 1-9 Remove the screws and push out the counter from the cover.

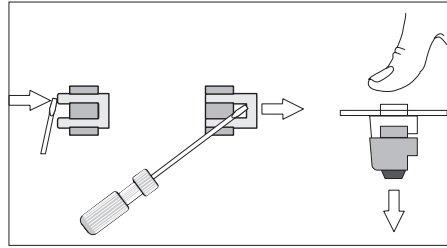

Figure 1-10 Removing feet from the cover.

- Remove the four feet from the cover.
- Use a screwdriver as shown in the illustration or a pair of pliers to remove the springs holding each foot, then push out the feet.
- Remove the two plastic labels that cover the screw holes on the right and left side of the front panel.
- Push the counter back in the cover.
- Turn it upside down.
- Install the two screws (A) at the bottom.
- Install the two rear feet with the screws (B) to the rear panel.
- Fasten the brackets at the left and right side with the screws included.
- Fasten the front panel and mounting plate.

Reversing the rack mount kit

The counter may also be mounted to the right in the rack. To do so, first remove the plate on the long bracket and fasten it on the short one, then perform the preceding steps.

The long bracket has an opening so that cables for Input A, B, and C can be connected inside the rack.

Chapter 2

Using the controls

Basic Controls

LOCAL/PRESET

If in *Local* mode: Presets the instrument to default settings, see page 2-13.

If in *Remote* mode: the counter switches to local operation.

EXT REF

Switches between the external and the internal Time Base reference.

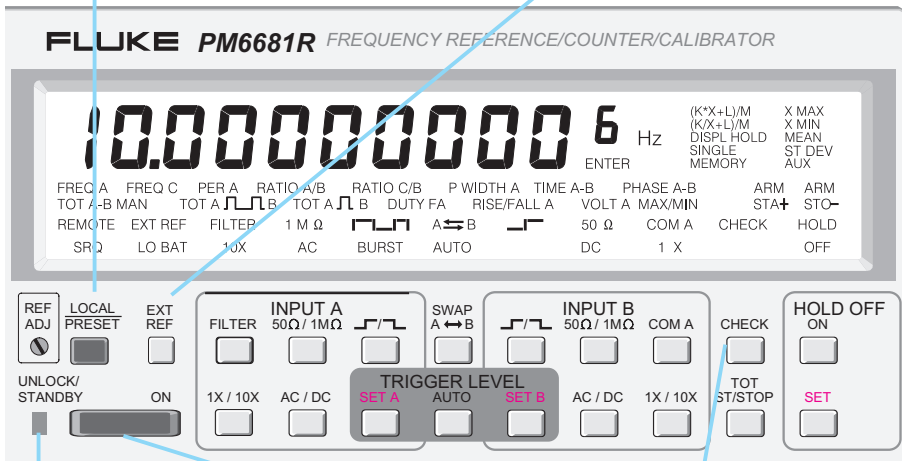

STANDBY LED

PM6680B/PM6681: Lights when the counter is OFF, but power is available to an oven oscillator
PM6681R: This LED (UNLOCK/STANDBY) also indicates when the rubidium oscillator is unlocked during the warming up phase (4-6 min. after switched ON). Once the LED switches off, the PM6681R can be used.

STANDBY /ON

Press ON and the counter turns on and returns to the settings it had when turned off.

To select default settings, press PRESET.

CHECK

connects the internal timebase reference to the counter logic to allow test of all measuring functions, except V_{MAX}/MIN. (The reference frequency is 10 MHz for the PM6680B and 100 MHz for the PM6681).

MENU

If you press MENU the display shows all selectable functions and the current selection blinks.

FUNCTION

Selects measuring function from the list of functions under the numeric field in the display.

AUX MENU

Gives you access to additional functions, See chapter 7.

KEYBOARD

Use DATA ENTRY keys to key in numerical values. SELECT/SET can also be used to increase/ decrease a value for some functions.

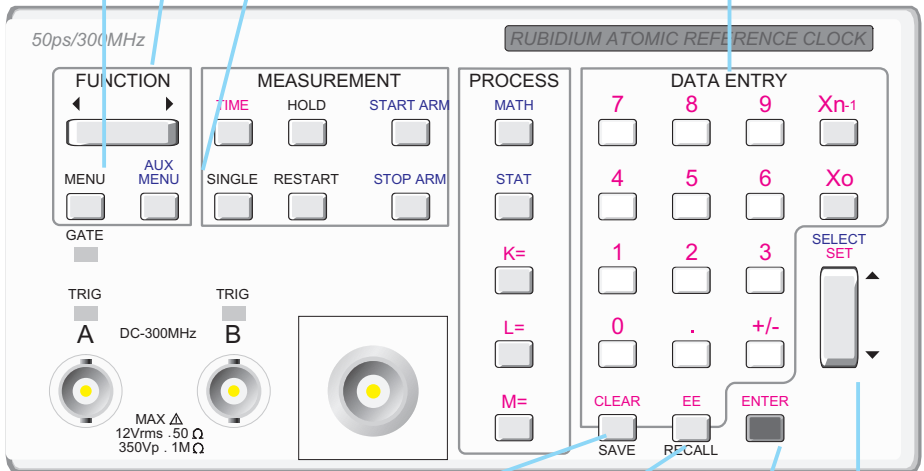
**SAVE/ CLEAR**

Press SAVE and then a number between 0 and 19 to store a front panel configuration. The MEMORY indicator is only on as long as no changes from the saved setting have been made.

CLEAR deletes erroneous keyboard entries.

RECALL/EE

Press RECALL and a number to recall a stored front panel configuration. Also used to enter an exponent (EE).

ENTER

Confirms a selection.

SELECT/ SET

Steps up/down numerical values and scrolls through selections. Confirm by pressing ENTER.

Input Controls

FILTER

Switches on or off the 100kHz LP-filter

IMPEDANCE

Sets the input impedance 50Ω or 1MΩ

SLOPE

Positive or negative trigger slope

SWAP A ↔ B

When ON, input A and B are swapped after the input controls. Input A becomes Input B and vice versa. (Does not work for Rise/Fall A).

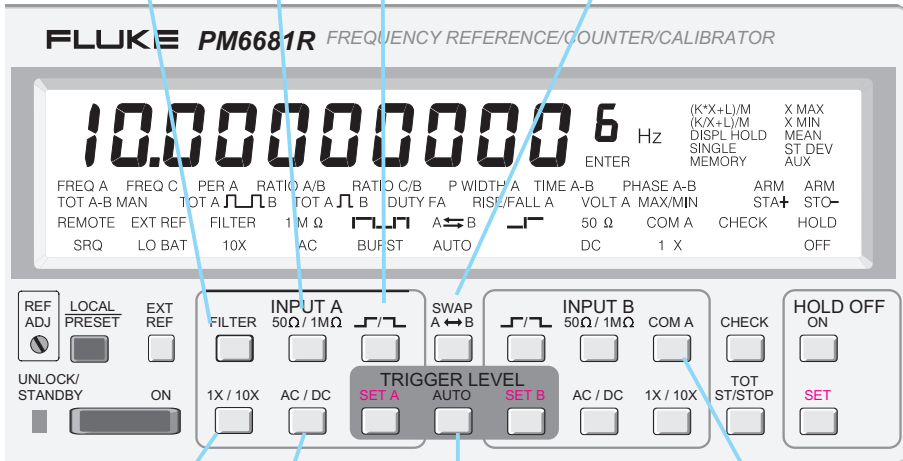

X1/X10

Attenuation 1X or 10X

TRIGGER LEVEL

Read or set the trigger levels, Each level is variable between -5.1 and + 5.1 V. (-51 and +51V if attenuator is set to 10X.) AUTO selects 50% of V_{PP} as trigger level for both A and B inputs.(10% and 90% for Rise/Fall A.).

COUPLING

Select AC or DC coupling.

COM A

interconnects input A and B internally. COM A uses Input A connector and settings.

TRIG LED'S

Blinking = Correct triggering, ON = Signal above trigger level, OFF = Signal below trigger level. Indicates triggering also while you set the trigger level using the SELECT/SET.

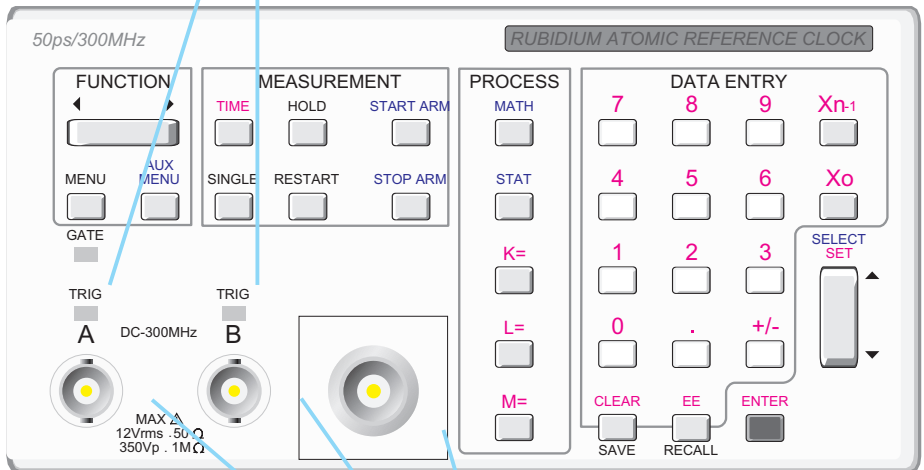
**INPUT CONNECTORS**

A and B inputs: standard BNC connector; 1.3 GHz Input C: (Option) N-type connector: All other HF-input options.

Measurement Control Keys

HOLD OFF

ON: Switches Hold Off on or off

SET: Read or set Hold Off time. The time is variable between 200ns and 1.67s for the PM6680B and 50 ns to 1.34 s for the PM6681.

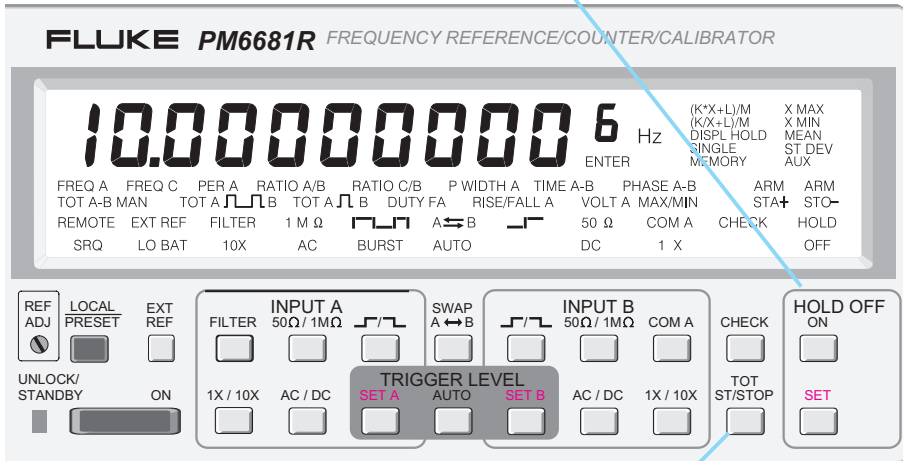

TOTALIZE START/STOP

Used to open/ close the gate in TOT A-B MAN. Reset value with RESTART.

MEASUREMENT TIME

Sets measurement time between 800ns and 400s. (80 ns and 400s on the PM6681)

If single is selected the set measurement time becomes the Display Time (pause between measurements).

SINGLE

When on, the result from each measurement is displayed. When off, the counter averages all data captured during the set measurement time.

DISPLAY HOLD

Freezes the display until you initiate a new measurement by pressing RESTART or by changing any setting.

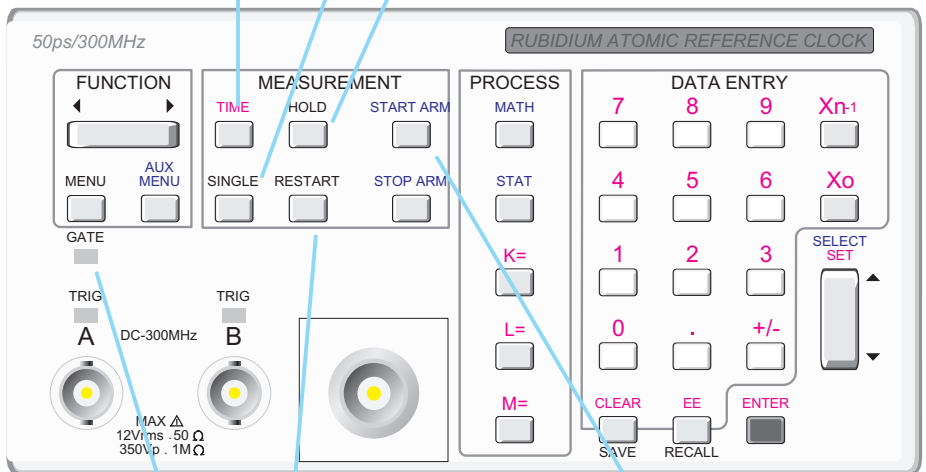
**GATE LED**

On when a measurement proceeds. A Gate signal is also available on the 'Gate Open' output on the rear panel.

RESTART

Interrupts the measurement, clears the display, and starts a new measurement.

ARM

Activates external arming. Push START or STOP. Select Off, Pos, or Neg with the SELECT/SET key. End with ENTER. Arming delay and channel can be set via AUX MENU.

Processing

MATHEMATICS

Press MATH and use SELECT/SET key to choose $(K \cdot X + L) / M$ or $(K / X + L) / M$. K, L, and M keys set the constants.

X_{n-1}

Uses the previous (old) measurement result in mathematics. Press K=, L=, or M= then X_{n-1} and confirm by pressing ENTER. X_{n-1} is continuously updated to the measurement result prior to the current result.

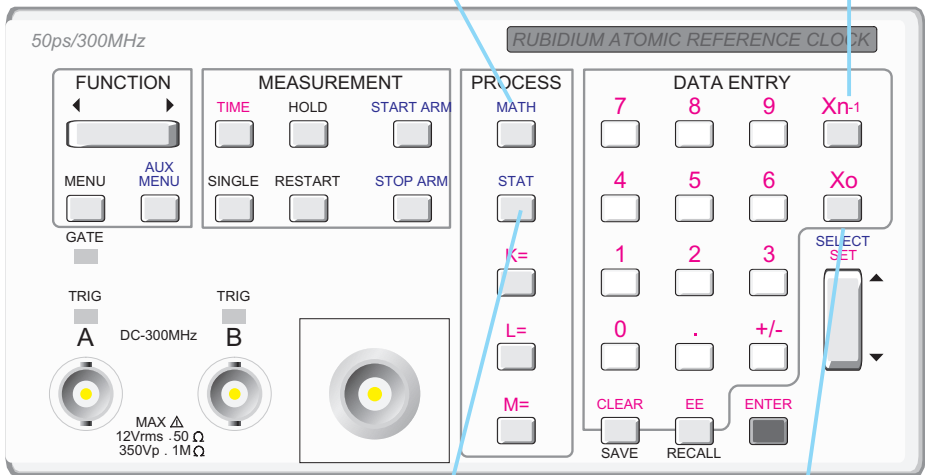

STATISTICS

Press STAT and use SELECT/SET key to choose Max, Min, Mean, or Standard Deviation. The number of samples is 100 but can be altered via AUX MENU. (To capture data quickly the measurement time should be short.)

X_0

Captures the most recently displayed measurement result and uses it as a constant in mathematics. Press K=, L=, or M= then X_0 . Press ENTER to store the displayed value as a constant.

Display

MEASURING FUNCTIONS

The current measuring function is shown on the display.

If MENU is pressed, all possible selections are shown on the display and current setting is blinking.

Also watch the A \leftrightarrow B segment. If on, the inputs are swapped, for instance Ratio A/B is really Ratio B/A.

NUMERICAL PRESENTATION

A 10-digit display used to show measuring results and other values. The display always shows basic units (Hertz, seconds or Volts) plus an exponent when necessary.

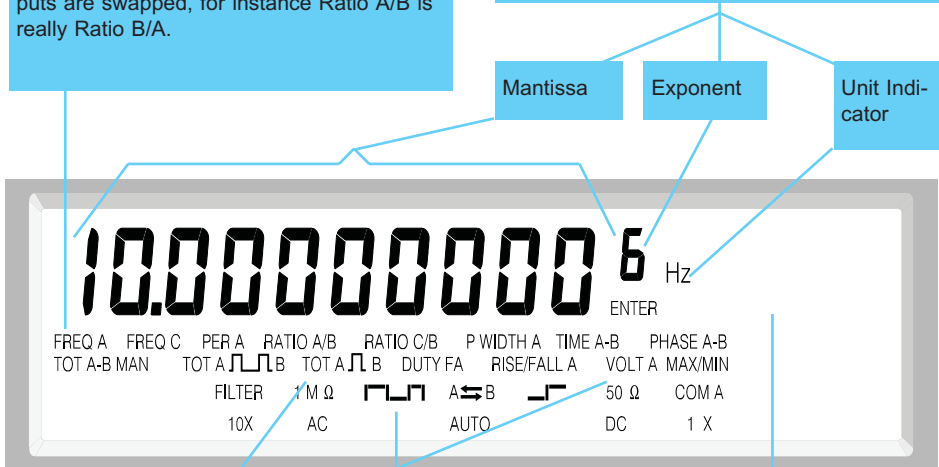

INPUT IMPEDANCE

Always shown for both inputs, to avoid impedance mismatch of connected cables and to avoid accidental switching to 50 Ω when a high amplitude (above 12 V_{RMS}) signal is connected.

ENTER

Blinks when the instrument wants you to confirm a selection by pressing ENTER. Steady ON if you can also confirm by pressing the SET key once more

INPUT SETTINGS

Input settings are shown on the display directly above the key used for each setting. Only the active settings for the inputs in use are shown.

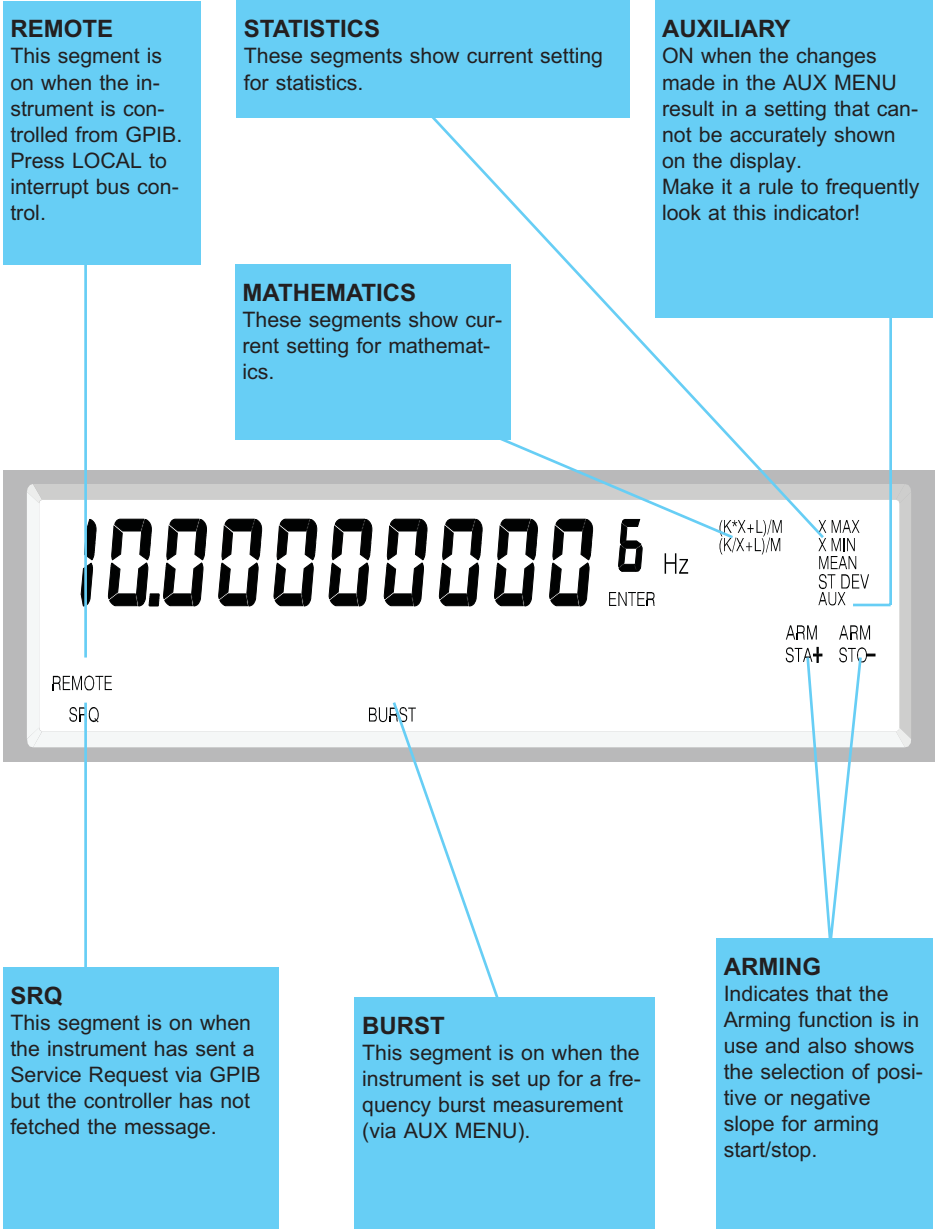

Rear Panel

PM6680B

Optional Rear inputs

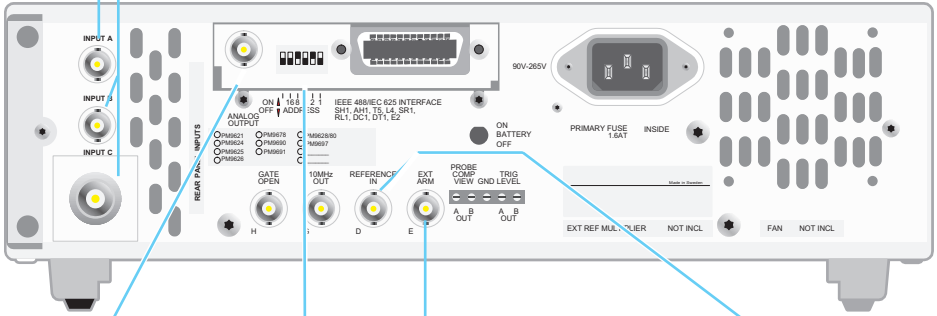

Analog output

GPIB address switch

External Arming input (or extra measuring input E)

External Reference input

Optional Rear inputs

Extra Reference outputs (PM6681R only)
Five 10 MHz outputs and one 5 MHz output

PM6681/ PM6681R

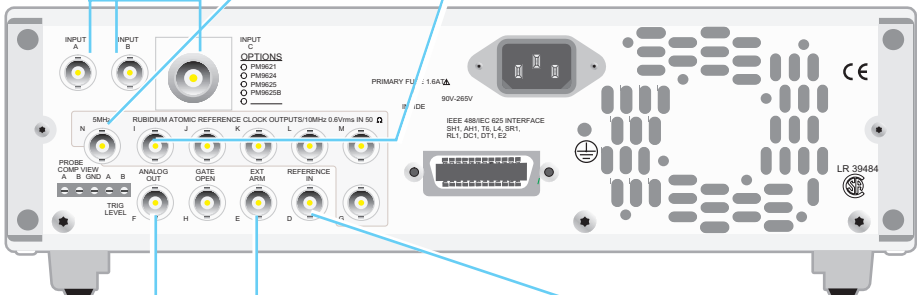

Analog output

External Arming input (or extra measuring input E)

External Reference input

Trig Level Outputs

These connectors at the rear panel output DC levels which represent the set trigger level. You can connect this signal to one channel of your oscilloscope and connect the measuring signal to the other channel. Now you can see where the counter triggers on the oscilloscope screen.

The PM6680B outputs a voltage that is 1/10 of the trigger level. The output range is -0.51 to $+0.51$ V in 2 mV steps and it is not affected by the attenuators.

The PM6681 outputs Trigger level/attenuator setting. The output range is -5.1 to $+5.1$ V in 1.25 mV.

Probe Comp View

If you want to use oscilloscope probes for time measurements you must calibrate the step response of the probes. Select a probe with a compensating range of at least 30pF.

- Set your timer/counter in default setting by pressing the **PRESET** key.
- Select non AUTO, x1.
- Connect a 2 kHz square wave with 4 V_{pp} amplitude to Input A via the probe you want to adjust.
- Connect the Probe Comp View output at the rear of the timer/counter to an oscilloscope. Use a probe that is correctly adjusted to the oscilloscope you use.
- Adjust the probe connected to input A until the edge of the pulse is as sharp as possible.

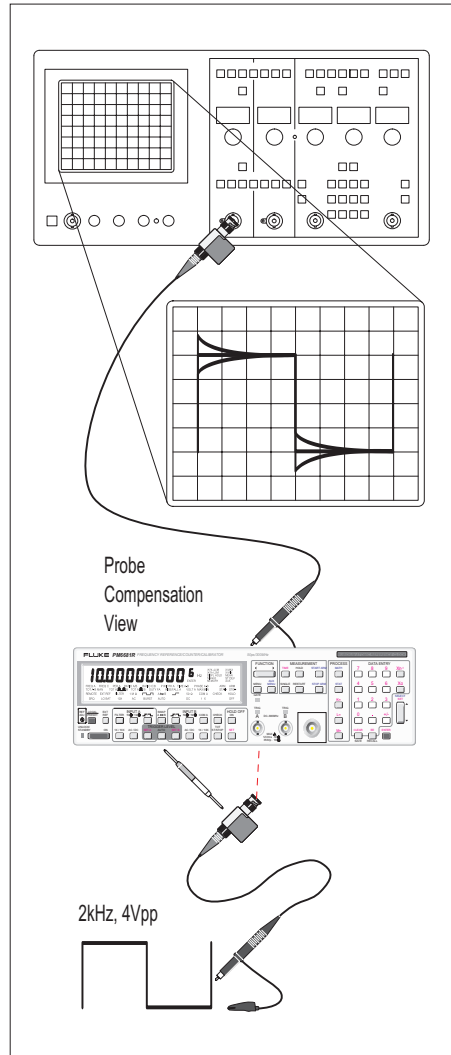

Figure 2-1 Adjusting the step response of a probe to fit the timer/counter.

If you have a PM6681, you can use TimeView for probe compensation. See the TimeView chapter of this manual.

Default Settings (after PRESET)

PM6680B

The counter presets immediately when you press **PRESET**.

PARAMETER	VALUE/ SETTING
Input A:	
Trigger level	AUTO
Impedance	1 M Ω
Manual Trigger level (Controlled by AUTO-trig)	0V
Manual Attenuator (Controlled by AUTO-trig)	1X
Coupling	AC
Trigger slope	Pos
Filter	OFF
Input B:	
Trigger level	AUTO
Impedance	1 M Ω
Manual Trigger level (Controlled by AUTO-trig)	0V
Manual Attenuator (Controlled by AUTO-trig)	1X
Coupling	DC
Trigger slope	Pos
Common	OFF
Arming:	

PM6681

The counter presets immediately when you press **PRESET**.

The settings used before preset are stored in memory 0, so press **RECALL**, then **0** and **ENTER** to recall the previous setting.

PARAMETER	VALUE/ SETTING
Start	OFF
Stop	OFF
Delay	Start, Time, OFF
Channel	Ext Arm Input E
Statistics:	
Statistics	OFF
Mathematics	OFF
Sample size in Statistics	100
Sample size in Time Inter- val Average	100
Mathematical constants:	
K= and M=	1
L=	0
Miscellaneous:	
Function	FREQ A
Time out	100 ms, OFF
Measurement time	0.2 s
Check	OFF

Using the controls

PARAMETER	VALUE/ SETTING
Single cycle	OFF
Analog output control	OFF
Hold Off	Time, OFF
Memory Protection (Memory 10 to19)	OFF
Auxiliary functions	All switched OFF
Blank LSD	OFF

Chapter 3

Input Signal Conditioning

Input Amplifier

Input amplifiers are used to adapt measuring signals to the measuring logic of the timer/counter. These amplifiers have many controls and it is essential to understand how these controls work together and how they affect the signal.

The block diagram below shows the order in which the different controls are connected.

This is not a complete technical diagram. It is only intended to help understanding the controls.

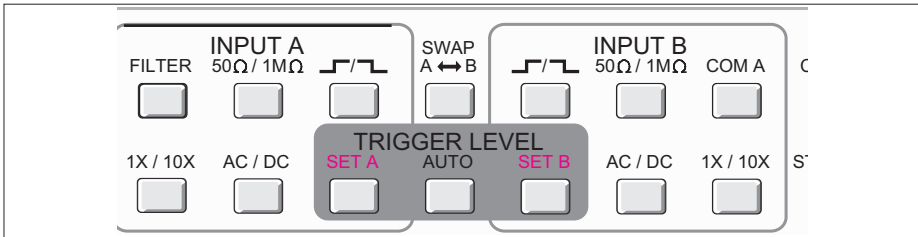

Figure 3-1 These keys control the input amplifiers.

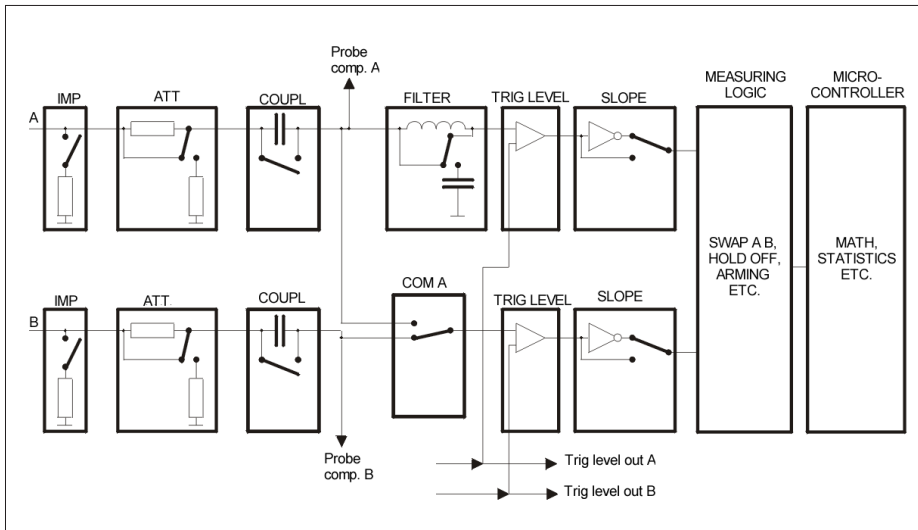
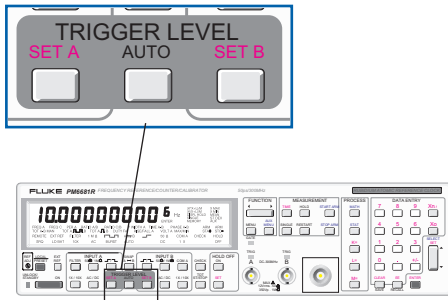

Figure 3-2 Block diagram of the signal condition.

Trigger Level



AUTO



Turn on AUTO, and the counter automatically measures the peak-to-peak levels of the input signal and sets the trigger level to 50% of that value. When the instrument is in AUTO mode, it also selects attenuation automatically.

If the Rise&Fall time function is selected, AUTO sets the trigger levels to 10% and 90% of the amplitude. The 10% level can be read by pressing **SET A** and the 90% level by pressing **SET B**.

Speed

The Auto-function measures amplitude and calculates trigger level rapidly, but if you aim at higher measurement speed, use the Auto Low function in the Auxiliary Menu.

To set the lowest frequency Auto Low uses for calculation in the PM6681 (for the PM6680B see page 7-11):

- Press **AUX MENU**.
- Select Auto Lo confirm with **ENTER**.
- Use **SELECT/SET** or use the keypad to set the low frequency limit that should be used during the trigger level calculation, (default 100 Hz).
- Confirm with **ENTER**.

Typical time to determine trigger levels

Measuring function	100 Hz freq. limit (normal)		10 kHz freq. limit	
	PM6680 B	PM6681	PM6680 B	PM6681
Freq A	50 ms	85 ms	25 ms	15 ms
Time A-B	80 ms	170 ms	40 ms	30 ms

Table 3-1 Time to determine trigger levels

High speed voltage (PM6680B) or a high low-frequency limit in Auto Low (PM6681) detects the level faster. Fixed trigger levels also increase speed, See also “Converting AUTO to Fixed” below.

Fixed levels

SET A



Press **SET A** or **SET B** keys to read the current trigger level and to set fixed trigger levels.

SET B



Values can either be entered via the keyboard or stepped up or down with the **SELECT/SET** key.

Press **ENTER** to confirm your selection.

When a fixed trigger level is set, AUTO is turned off for that input.

Ranges for trigger level A and B:

Att.	Trigger Level Range	Minimum step	
		PM6680 B	PM6681
X1	-5.1 to +5.1 V	20 mV	1.25mV
X10	-51 to +51 V	200 mV	12.5mV

Table 3-2 Ranges for trigger level A and B

■ Auto once

Converting “Auto” to “Fixed”

The trigger levels used by the auto trigger can be frozen and turned into fixed trigger-levels. When AUTO is on and you press **SET A** or **SET B**, you will see the trigger-level selected by the instrument. If you want to enter this value as fixed trigger-level, just press **ENTER**. The instrument now returns to measuring but with the trigger level programmed as fixed. Repeat the above for the other input if you want fixed trigger level there too.

NOTE: By following this procedure you can use auto trigger on one input and fixed trigger levels on the other. The fixed level can be adjusted by pressing the appropriate SET key once again and entering a new value. The AUTO annunciator on the display is on as long as one of the currently used channels is in auto mode.

To check which inputs have autotrigger when the AUTO annunciator is on:

- Press **AUX MENU**.
- Select **RU. CODES**.
- Check the last digit (called .T) in the code according to the following table:

.T	Auto trig A	Auto trig B
.0	off	off
.1	off	on
.2	on	off
.3	on	on

Table 3-3 Trigger settings

■ Sensitivity

The sensitivity of the counter is normally fixed at 20 mVp-p. For one-channel measurements, you can vary the width of the hysteresis band between 30 mVp-p (60mV for the PM6680B) and 10 Vp-p.

Press **AUX MENU**.

Select **VAR. HYST. A** with the **SELECT/SET** key.

Press **ENTER**.

Turn on variable hysteresis by selecting ON with the **SELECT/SET** key, confirm with **ENTER**.

When you turn on Variable Hysteresis A, AUTO is switched on. Here AUTO sets the upper level of the hysteresis band to 75% and the lower level to 25%. The upper level can be read and set with **SET A** and the lower level with **SET B**.



*Variable hysteresis A has an upper frequency limit of 120 MHz and is restricted to **FREQ A** for the PM6680B, while it can be used in all one-channel measurements on input A with the PM6681.*

■ Trigger indicators

One indicator for each of input A and B shows the status:

Blinking The signal crosses the hysteresis band and the input is triggering correctly.

On The signal is above the trigger level.

Off The signal is below the trigger level.



*The trigger indicators operate while you set the trigger level via the **SELECT/SET** key. This way you can see when the input triggers correctly even though you cannot see the measuring results on the display.*

Filter

■ Analog Low-pass Filter Input A

If you cannot obtain a stable reading, the signal-to-noise ratio is too poor (assumably poorer than -6 to -10 dB), and you should use a filter.

FILTER



The counter has an analog LP filter with cutoff frequency of approximately 100 kHz, and a signal rejection of 40 dB at 1 MHz.

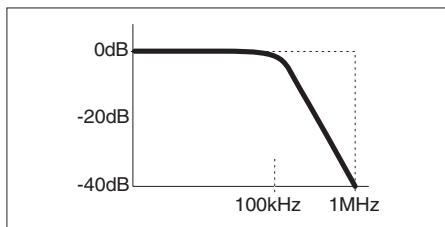

Figure 3-3 Characteristics of LP filter.

Accurate frequency measurements of noisy LF signals (up to 200 kHz) can be made, when the noise components have significantly higher frequencies than the fundamental signal.

■ Digital Low-pass Filter Input A and B

With trigger Hold Off, it is possible to insert a dead time in the input trigger circuit. This means that the input of the counter ignores all hysteresis band crossings by the input signal during a preset time.

When you set the Hold Off time to approx. 75% of the cycle time of the signal, (erroneous) triggering is inhibited around the point where the input signal returns through the hysteresis band. When the signal reaches the trigger point of the next cycle, the set Hold Off time has elapsed and one (correct) new triggering occurs.

To use the Hold Off feature effectively you must have a rough idea of the frequency to be measured; otherwise, setting the Hold Off time is not easy.

A Hold Off time that is too long may give a perfectly stable reading, but have a frequency that is too low. In such a case, triggering occurs only on every 2nd, 3rd or 4th cycle. A Hold Off time that is too short $< \frac{1}{2}$ cycle time also leads to a stable reading. Here one noise pulse is counted for each half-cycle.

Use an oscilloscope for verification if you are in doubt about which frequency you measure on.

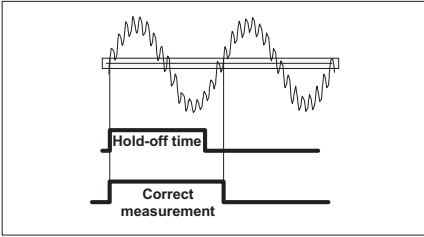

Figure 3-4 Digital LP filter using Hold Off operates in the measuring logic, not in the input amplifier.

Impedance

50Ω/1MΩ The input impedance can be set to 1MΩ or 50Ω.



CAUTION: Switching the impedance to 50Ω when the input voltage is above 12VRMS may cause permanent damage to the input amplifier.

Slope



One press on the SLOPE key changes trigger slope from positive to negative or from negative to positive. Check the annunciator on the display directly above the key to see the selected slope. Trigger slope is essential for time measurements, and totally unimportant for frequency measurements.

Attenuation

1X/10X One press on the 1X/10X key changes attenuation from 1X to 10X or from 10X to 1X. Check the annunciator on the display directly above the key to see selected attenuation.



Use the attenuator to attenuate excessive signals.

DC / AC Coupling

AC/DC One press on the AC/DC key changes attenuation from AC to DC or from DC to AC.



Check the annunciator on the display directly above the key to see selected coupling.

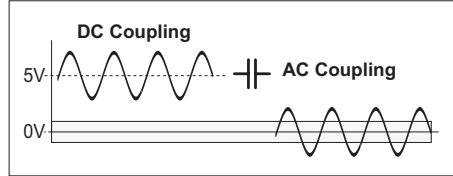

Figure 3-5 AC coupling a symmetrical signal.

Use the AC coupling feature to eliminate unwanted DC signal components. Always use AC coupling when the AC signal is superimposed on a DC voltage, which is greater than can be offset with the counter's trigger level setting. However, we recommend AC coupling in many other measurements anyway.

When you measure symmetrical signals, such as sine and square waves or triangles, AC coupling filters out all DC components. This means that a 0 V trigger level is always centered around the middle of the signal where triggering is most stable.

Signals with changing duty factor or with a very low duty factor do require DC coupling. Figure 3-6 shows how pulses can be missed, while shows that triggering does not occur at all because the signal amplitude and hysteresis band are not centered.

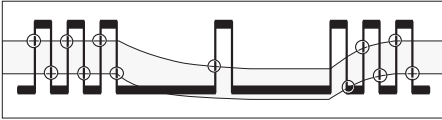

Figure 3-6 Missing trigger events due to AC coupling.

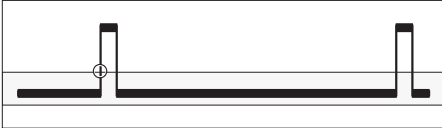

Figure 3-7 AC coupling a signal with low duty factor.

How to Reduce or Ignore Noise and Interference

Sensitive counter input circuits are of course also sensitive to noise. By matching the signal amplitude to the counter's input sensitivity, you reduce the risk for erroneous counts from noise and interference. These could otherwise ruin a measurement.

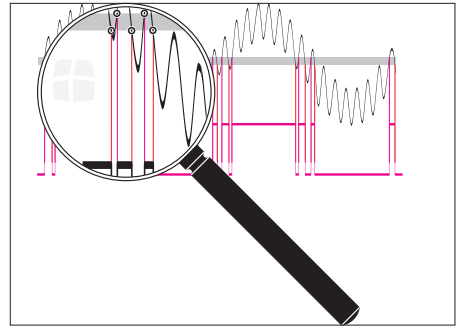

Figure 3-8 Narrow hysteresis gives erroneous triggering on noisy signals.

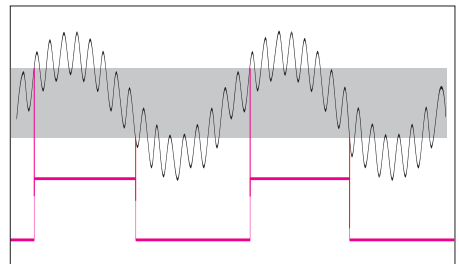

Figure 3-9 Wide trigger hysteresis gives correct triggering.

To ensure reliable measuring results, the counter has the following functions to reduce or eliminate the effect of noise:

- 10X input attenuator
- Continuously variable trigger level
- Continuously variable hysteresis for some functions
- Analog low-pass noise suppression filter
- Digital low-pass filter, (frequency trigger Hold Off)

To make reliable measurements possible on very noisy signals, you may use several of the above features simultaneously.

Optimizing the input amplitude and the trigger level, using the attenuator and the trigger control, is independent of input frequency and useful over the entire frequency range. LP filters function selectively over a limited frequency range.

Trigger Hysteresis

The signal needs to cross the 20 mV input hysteresis band before triggering occurs. This hysteresis prevents the input from self-oscillating and reduces its sensitivity to noise. Other names for trigger hysteresis are “trigger sensitivity” or “noise immunity”, which explain the various characteristics of the hysteresis.

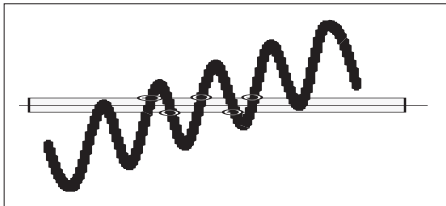

Figure 3-10 Erroneous counts when noise passes hysteresis window

Figure 3-8 and Figure 3-11 show how spurious signals can cause the input signal to cross the trigger or hysteresis window more than once per input cycle and cause erroneous counts.

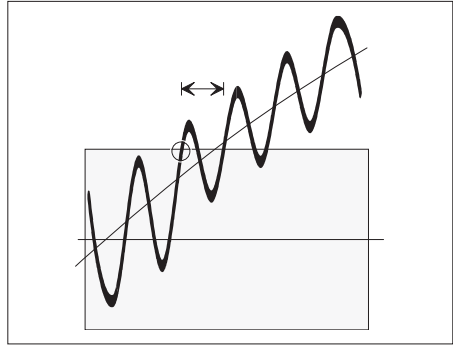

Figure 3-11 Trigger Uncertainty due to Noise.

Figure 3-10 shows that less noise still affects the trigger point by advancing or delaying it, but it does not cause erroneous counts. This trigger uncertainty is of particular importance when measuring low frequency signals, since the signal slew rate (in V/s) is low for LF signals. To reduce the trigger uncertainty, it is desirable to cross the hysteresis band as fast as possible.

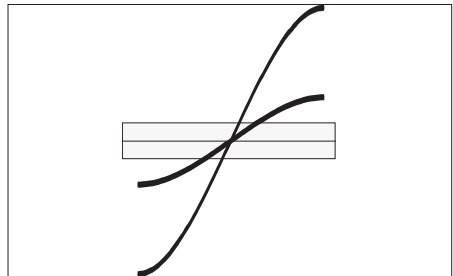

Figure 3-12 Low amplitude delays the Trigger Point

Figure 3-12 shows that a high amplitude signal passes the hysteresis faster than a low amplitude signal. For low frequency measurements where the trigger uncertainty is of importance, do not attenuate the signal too much, and set the sensitivity of the counter high.

In practice however, trigger errors caused by erroneous counts (Figures 3-8 and 3-10) are much more important and require just the opposite measures to be taken.

To avoid erroneous counting caused by spurious signals, you need to avoid excessive input signal amplitudes. This is particularly valid when measuring on high impedance circuitry and when using the $1\text{M}\Omega$ input impedance. Under these conditions, the cables easily pick up noise.

External attenuation and the internal 10X attenuator reduces the signal amplitude, including the noise, while the internal sensitivity control in the counter reduces the counter's sensitivity, including sensitivity to noise. Reduce excessive signals with the 10X attenuator or with external coaxial attenuators. If the signal has a poor signal-to-noise ratio (less than 20dB), you may have to use the Variable Hysteresis A.

How to use Trigger Level Setting

For most frequency measurements, the best triggering is obtained by positioning the trigger level at mid amplitude.

When measuring LF sine wave signals with little noise, you may want to measure with a high sensitivity (narrow hysteresis band) to reduce the trigger uncertainty. Triggering at or close to the middle of the signal leads to the smallest trigger (timing) error since the signal slope is steepest at the sine wave center, see Figure 3-13.

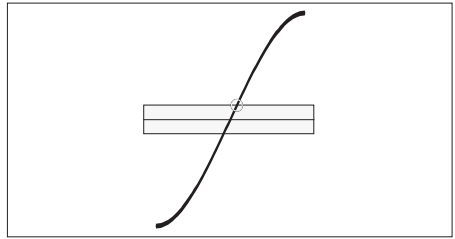

Figure 3-13 Timing error due to slew rate.

When you have to avoid erroneous counts due to noisy signals, see Figure 3-11, expanding the hysteresis window gives the best result when you center the window around the middle of the input signal. The input signal excursions beyond the hysteresis band should be equally large.

■ AUTO Trigger

For frequency measurements, the Auto Trigger function automates the trigger level setting to 50 % of the peak to peak amplitude. It does this with a successive approximation method, by which the signal's MIN. and MAX. levels are identified, i.e., the levels where triggering just stops. After this MIN./MAX. probing, the counter sets the trigger level to the average value of these two extremes.

Before each frequency measurement the counter repeats this signal probing to identify new MIN/MAX values. A prerequisite to enable AUTO triggering is therefore that the input signal is repetitive, i.e., ≥ 100 Hz. Another condition is that the signal amplitude does not change significantly after the measurement has started.

NOTE: AUTO trigger limits the maximum measuring rate when an automatic test system makes many measurements per second. Here you can increase the measuring rate by switching off this probing if the signal amplitude is constant:

One single command and the AUTO trigger function determines the trigger level once and enters it as a fixed trigger level.

■ Harmonic Distortion

As rule of thumb, stable readings are free from noise or interference.

However, stable readings are not necessary correct; harmonic distortion can cause erroneous yet stable readings.

Sine wave signals with much harmonic distortion, Figure 3-15, can be measured correctly

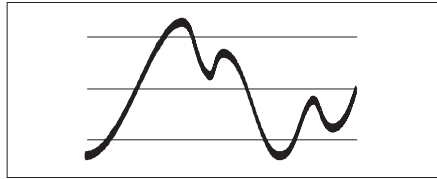

Figure 3-14 Variable sensitivity

by shifting the trigger level to a suitable level or by using the continuously variable sensitivity setting (Figure 3-14) that is accessible via the Aux Menu. You can also use trigger Hold Off.

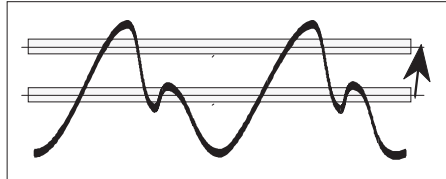

Figure 3-15 Harmonic distortion.

Chapter 4

Measuring Functions

Introduction to this Chapter

This chapter describes the different measuring functions of the counter. The functions have been grouped as follows:

Frequency measurements

- Frequency.
- Period.
- Ratio.
- Burst frequency and PRF.
- FM.
- AM.

Time measurements

- Time interval.
- Pulse width.
- Duty factor.
- Rise/Fall-time.

Totalize measurements

- Totalize A minus B Manual.
- Totalize A minus B during a preset time.
- Totalize A started/stopped by B.
- Totalize A gated by B, single.
- Totalize A gated by B accumulated during a preset time.

Phase

Voltage

- VMAX, VMIN.
- VPP.
- Gated voltage measurements.

Selecting Function

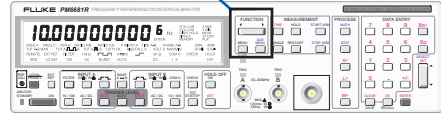
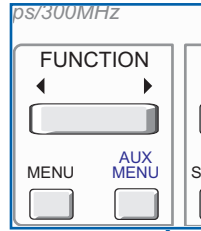

FUNCTION

Press one end of the **FUNCTION** key. This scrolls the function cursor on the display. Release the key when the desired function is highlighted.

MENU

Press **MENU** and all choices on the display will show. The selected function blinks.

AUX MENU

Press **AUX MENU** to get a menu with more selections.

Frequency Measurements

FREQ A

The PM6680B measures frequency between 0 Hz and 225 MHz on the A input while the PM6681 measures between 0 Hz and 300 MHz.

Frequencies above 100 Hz are best measured using the AUTO triggering and the default measurement time of 200 ms. When preset, the counter always starts up with Frequency A selected and AUTO on, ready to measure.

■ Summary of Settings for Good Frequency Measurements:

- AC-coupling.
- Variable hysteresis.

FREQ C

With an optional prescaler both counters can measure up to 4.5 GHz on the optional C-input. This input is fully automatic and no settings are available.

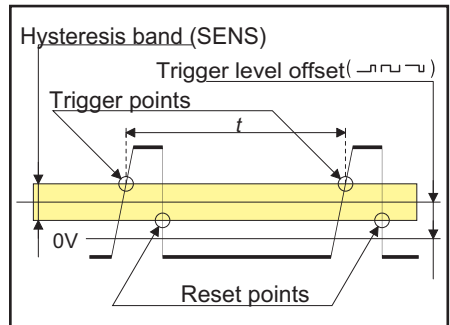

Figure 4-1 Frequency is measured as the inverse of the time between the one trigger point and the next. $f = \frac{1}{t}$

PER A

From a measuring point of view, the period function is identical to the frequency function. This is because the period of a cyclic signal has the reciprocal value of the frequency ($\frac{1}{f}$).

In practice there are two minor differences.

1. Where the counter calculates **FREQUENCY** as:

$$f = \frac{\text{number of cycles}}{\text{actual gate time}}$$

it calculates **PERIOD** as:

$$p = \frac{\text{actual gate time}}{\text{number of cycles}}$$

2. In the **PERIOD** mode, the counter uses no prescaler, resulting in a 160 MHz maximum frequency.

All other functions and features as described earlier under “Frequency” apply to Period measurements.

RATIO A/B

To find the ratio between two input frequencies, the counter counts the cycles on two channels simultaneously and divides the result on the primary channel by the result on the secondary channel.

Ratio can be measured between inputs A and B or between inputs C and B.



Note that the resolution calculations are very different as compared to frequency measurements.

BURST

A burst signal as in Figure 4-2 has a carrier wave (CW) frequency and a modulation frequency, also called the pulse repetition frequency (PRF), that switches the CW signal on and off.

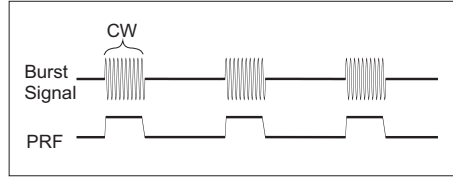

Figure 4-2 Burst signal.

The counter can measure burst signals with or without external arming signals. To measure with external arming signals, See Chapter 5 “Measurement Control” about arming and arming delay.

When measuring bursts on the A-input, the maximum burst frequency is 160 MHz, and the minimum number of cycles in a burst is three.

■ Triggering

Bursts with a PRF above 50 Hz can be measured with auto triggering on.

The out-of-sync error described under heading “Possible errors” on page 4-5 may occur more frequently when using autotrigger.

When PRF is below 50 Hz and when the gap between the bursts is very small, use manual triggering.

Try using **auto once** to make the counter set fixed trigger levels; it will work in most cases.

Burst Frequency with Auto Sync.

You can measure the frequency on input A and B to 160 MHz and on input C up to 3 GHz with the internally synchronized BURST function as follows:

- Select a measurement time that is shorter than the burst duration minus two burst cycles or pulses, (the minimum value to be subtracted is always 15 μ s).
- Press **AUX MENU**, select **burst**, and press **ENTER**.
- Select channel A, B, C or E as measurement input, and press **ENTER**.
- Press **HOLD OFF SET** and enter a sync delay longer than the burst duration and shorter than the burst repetition period. See Figure 4-5.
- Press **ENTER** to measure.

■ Selecting Measurement Time

The measurement time must fit inside the burst. Should the measurement also include a part of the burst gap, no matter how small, the measurement is ruined. Choosing a measurement time that is too short is better since it only reduces the resolution. Making burst frequency measurements on short bursts means using short measurement times, giving a poorer resolution than normally achieved with the counter.

■ How Does the Sync Delay Work?

The sync delay works as an internal start arming delay: it prevents the start of a new measurement until the set sync delay has expired. See Figure 4-3.

After the set measurement time has started, the counter synchronizes the start of the measurement with the second trigger event in the

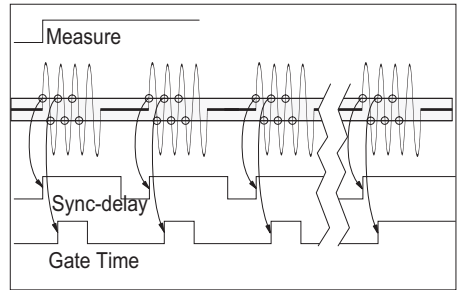

Figure 4-3 Measuring the frequency of the carrier wave signal in a burst.

burst. This means that the measurement does not start erroneously during the Burst Off duration or inside the burst.

■ Possible Errors

Before the measurement has been synchronized with the burst signal, the first measurement(s) could start accidentally during the presence of a burst. If this would happen and if the remaining burst duration is shorter than the set measurement time, the readout of the first measurement will be wrong. However, after this first measurement, a properly set start-arming sync delay time will synchronize the next measurements.

In manually operated applications, this is not a problem. In automated test systems where the result of a single measurement sample must be reliable, at least two measurements must be made, the first to synchronize the measurement and the second from which the measurement result can be read out.

Autosync on Slow-Starting Burst, (the PM6681 only)

Bursts may start a bit slowly especially RF bursts. The result when measuring the burst frequency will then be erroneous unless the first few pulses are excluded from the measurement.

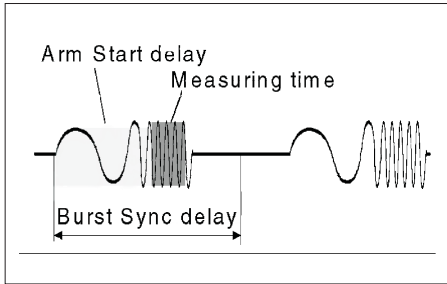

Figure 4-4 Three time values must be set to measure the correct part of a burst

■ Preparations

- Turn off the AUTO function.
- Set the triggering so that the counter triggers correctly.

■ Turning on Burst Measurements

- Press **AUX MENU**.
- Select **burSt**.
- Press **ENTER**.
- Select A, B, C or E and press **ENTER**.
- Press **HOLD OFF SET** and enter a sync delay longer than the burst duration and shorter than the burst repetition period. See Figure 4-5.
- Press **ENTER** to measure.
- Press **MEAS TIME** and select the shortest time.
- Increase the measurement time until you get the number of digits you want. Take

care not to increase it so much that the counter counts incorrectly.

- Now the counter measures the burst frequency on the burst, starting with the first pulse.

So far this description is the same as for earlier firmware releases.

■ Turning on Arming Delay

- Press **START ARM**.
- Select **POS** and press **ENTER**.
- Select **CHAR E** and press **ENTER**.
- Select **DELAY t.** if you want a time delay or **DELAY Ent.** if you want an event delay, and press **ENTER**.
- Enter an ARM START delay that equals the part of the burst that you want to mask and press **ENTER**.

Now the counter measures on the remaining part of the burst.



As long as BURST is ON, the arming delay is triggered by the burst itself, not by the arming signal on input E.

■ Turning Off

Don't forget to turn off arming start when you turn off BURST in the AUX MENU or change function. Otherwise, the counter will not measure unless there is an arming signal on the E input.

Burst PRF

The burst repetition frequency can be measured by using the Hold Off:

- Press **TIME** and enter a measurement time that gives you the resolution you want.
- Turn off **SINGLE**.
- Press **HOLD OFF ON**.
- Press **HOLD OFF SET** and enter a sync delay longer than the burst duration and shorter than the burst repetition period. See Figure 4-5.
- Press **ENTER** to measure.

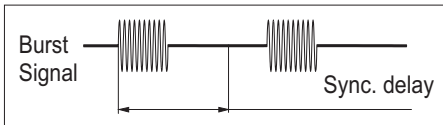

Figure 4-5 Set the sync delay so that it expires in the gap between the bursts.

■ How does PRF work?

The PRF is the number of bursts per second. This means that the counter must count one pulse in each burst.

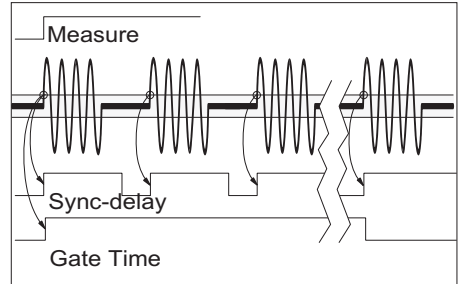

Figure 4-6 Measuring Burst Pulse Repetition Frequency.

When the PRF function is on and the counter is triggered, all further input triggering is blocked until the PRF sync delay has expired. When correctly set, the PRF delay should expire in the gap between the bursts, making the counter ready to measure again when the next burst arrives.

The selected measurement time is not used for synchronization. It only decides how many bursts the counter should use in its averaging, i.e., the resolution.

Frequency Modulated Signals

A frequency modulated signal is a carrier wave signal (CW frequency= f_0) that changes in frequency to values higher and lower than the frequency f_0 . It is the modulation signal that changes the frequency of the carrier wave.

The counter can measure:

f_0 Carrier frequency.

f_{max} Maximum frequency.

f_{min} Minimum frequency.

Δf_{max} Modulation swing = $f_{max} - f_0$.

Carrier Wave Frequency f_0

To determine the carrier wave frequency, measure f_{mean} which is a close approximation of f_0 .

Select the measurement time so that the counter measures an integral number of modulation periods. This way the positive modulations compensate negative modulations.

Example: If the modulation frequency is 50 Hz, the measurement time 200ms will make the counter measure 10 complete modulation cycles.

If the modulation is non-continuous, like a voice signal, its is not possible to compensate positive modulations with negative modulations. Here, part of a modulation swing may remain uncompensated for, and lead to a measuring result that is too high or too low.

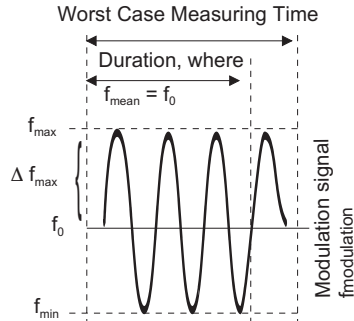

Figure 4-7 Frequency modulation

In the worst case, exactly half a modulation cycle would be uncompensated for, giving a maximum uncertainty of:

$$f_0 - f_{mean} = \pm \frac{\Delta f_{max}}{t_{measuring} \times f_{modulation} \times \pi}$$

For very accurate measurements of the carrier wave frequency f_0 , measure on the unmodulated signal if it is accessible.

■ Modulation Frequencies above 1 kHz

- Turn off **SINGLE**.
- Set a long measurement time that is an even multiple of the modulation frequency.

You will obtain a good approximation when you select a long measurement time, for instance 10 s, and when the modulation frequency is high, above 1000 Hz.

■ Low Modulation Frequencies

Press **STAT** and select **MEAN**. Make a large number of measurements and let the counter calculate the mean value of the results.

You will usually get good results with 0.1 s measurement time per sample and more than 30 samples ($n \geq 30$). You can try out the optimal combination of sample size and measurement time for specific cases. It depends on the actual f_0 and Δf_{\max} .

Here the sampling frequency of the measurement (1/measurement time) is asynchronous with the modulation frequency. This leads to individual measurement results which are randomly higher and lower than f_0 . The statistically averaged value of the frequency f_{mean} approaches f_0 when the number of averaged samples is sufficiently large.

When the counter measures instantaneous frequency values (when you select a very short measurement time), the RMS measurement uncertainty of the measured value of f_0 is:

$$f_0 - f_{\text{mean}} = \pm \frac{1}{\sqrt{2n}} \times \Delta f_{\max}$$

where n is the number of averaged samples of f .

f_{\max}

- Press **STAT** and select MAX.
- Press **TIME** and select a short measurement time.
- Set number of samples for statistics to 1000 or more.

f_{\min}

- Press **STAT** and select MIN.
- Press **TIME** and select a short measurement time.
- Set number of samples for statistics to 1000 or more.

Δf_{\max}

If you use the STATistics function, as described above, and the MATHematics function simultaneously, the counter can display Δf_{\max} immediately.

The MATH function $(K * X + L) / M$, can subtract the value of f_0 from the value of f_{\max} , which leads to:

$$\Delta f_{\max} = f_{\max} - f_0.$$

Enter the constants: $K=1$, $L=f_0$ and $M=1$.

Errors in f_{\max} , f_{\min} , and Δf_{\max}

A measurement time corresponding to $1/10$ cycle, or 36° of the modulation signal, leads to an error of approx 1.5%.

Select the measurement time:

$$t_{\text{measure}} \leq \frac{1}{10 \times f_{\text{modulation}}}$$

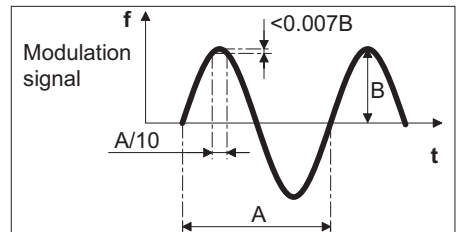

Figure 4-8 Error when determining f_{\max}

To be confident that the captured maximal frequency really is f_{\max} , you must select a sufficiently large number of samples, for instance $n \geq 1000$.

AM Signals

The counter can usually measure both the carrier wave frequency and modulation frequency of AM signals. These measurements are much like the burst measurements described in this manual.

Carrier Wave Frequency

The carrier wave (CW) is only continuously present in a narrow band in the middle of the signal. If the sensitivity is too low, cycles will be lost, and the measurement ruined.

To measure the CW frequency:

- Select a measurement time that gives you the resolution you want.
- Turn off **AUTO**.
- Select **AC**.
- Select **1X** to get a narrow hysteresis band.
- Press **SET A** to select 0V trigger level.
- If the counter triggers on noise, widen the hysteresis band with the ‘variable hysteresis’ function in the AUX MENU and measure.

Modulating Frequency

The easiest way to measure the modulating frequency is after demodulation. If no suitable

demodulator is available, use the Hold Off function to measure the modulation frequency in the same way as when measuring Burst PRF.

- Press **MEASUREMENT TIME** and enter a measurement time that gives you the resolution you want.
- Turn off **SINGLE**.
- Press **HOLD OFF ON**.
- Press **HOLD OFF SET** and enter a sync delay of approximately 75% of the modulating period. See Figure 4-5.
- Press **ENTER** to confirm.
- Turn off **AUTO**.

Press **SET A** and enter a trigger level that makes the counter trigger according to Figure 4-10A or use **AUX MENU** to set a hysteresis band that makes the counter trigger according to Figure 4-10B.

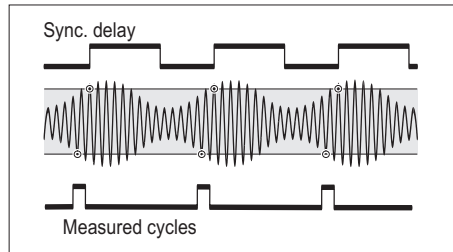

Figure 4-10 Measuring the modulating frequency.

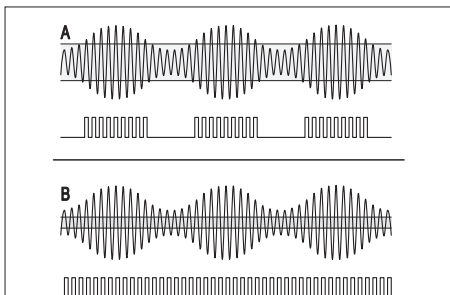

Figure 4-9 Effects of different sensitivity when measuring the CW Frequency of an AM signal.

Theory of Measurement

Reciprocal Counting

Simple frequency counters count the number of input cycles during a preset gate time, for instance one second. This leads to a ± 1 input cycle count error that, at least for low-frequency measurements, is a major contribution to uncertainty.

However, these counters use a high resolution, input signal synchronized, reciprocal counting technique. With this technique they count an exact number of integral input cycles, thereby omitting the ± 1 input cycle error.

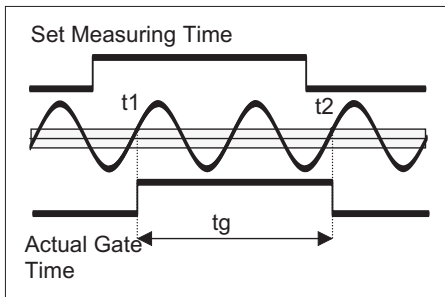

Figure 4-11 Synchronization of a measurement.

After the start of the set measurement time, the counter synchronizes the beginning of the actual gate time with the first trigger event (t_1) of the input signal it measures on.

In the same way, the counter synchronizes the stop of the actual gate time with the input signal, after the set measurement time has elapsed. The multi-register counting technique allows you to simultaneously measure the actual gate time (t_g) and the number of cycles (n) that occurred during this gate time.

Thereafter, it calculates the frequency according to Mr. Hertz's definition:

$$f = \frac{n}{t_g}$$

The PM6680B measures the gate time, t_g , with a resolution of 250 ps, and the PM6681 with 50 ps, independent of the measured frequency. Consequently the use of prescalers does not influence the quantization error. Therefore, the *relative* quantization error is: 250 ps/ t_g for the PM6680B and 50 ps/ t_g for the PM6681.

For a 1-second measurement time, this value is:

$$\frac{250 \text{ ps}}{1 \text{ s}} = 250 \times 10^{-12} = 2.5 \times 10^{-10}$$

(PM6680B)

and

$$\frac{50 \text{ ps}}{1 \text{ s}} = 50 \times 10^{-12} = 5 \times 10^{-11} \quad (\text{PM6681})$$

Except for very low frequencies, t_g and the set measurement time are nearly identical.

Sample-Hold

If the input signal disappears during the measurement, the counter will behave like a voltmeter with a sample-and-hold feature and show the result from the previous measurement.

Timeout

Mainly for GPIB use, you can manually select a fixed timeout in the AUX MENU. The range of the fixed timeout is 100 ms (64 ms for the PM6681) to 25.5s, and the default setting is OFF.

Select a time that is longer than the cycle time of the lowest frequency you are going to mea-

sure; multiply the time by the prescaling factor of the input channel and enter that time as timeout.

When no triggering has occurred during the timeout, the counter will show NO SIGNAL.

Measuring Speed - PM6681

The set measurement time determines the measuring speed. For continuous signals,

$$Speed \approx \frac{1}{t_g + 0.2}$$

when AUTO is on and can be increased to:

$$Speed \approx \frac{1}{t_g + 0.001}$$

with AUTO turned off, or via GPIB:

$$Speed \approx \frac{1}{t_g + 0.00012}$$

■ Frequency Average and Single Cycle Measurements

To reduce the actual gate time or measuring aperture, the counters have very short measurement times and a measurement time called SINGLE. The latter means that the counter measures during only *one cycle* of the input signal. In applications where the counter uses an input channel with a prescaler, the SINGLE measurement will last as many cycles as the division factor. If you want to measure with a very short aperture, use an input having a low division factor.

■ Prescaling May Influence Measurement Time

Prescalers do influence the actual gate time to some extent. For example this may be a problem when measuring the carrier wave frequency in a short burst signal.

Figure - shows the effect of the 2.7 GHz prescaler. For 16 input cycles, the

prescaler gives one (shaped) output cycle. When the counter uses a prescaler, it counts the number of prescaled output cycles, here $f/16$. The display shows the correct input frequency since the microcomputer compensates for the effect of the division factor d as follows:

$$f = \frac{n \times d}{t_g}$$

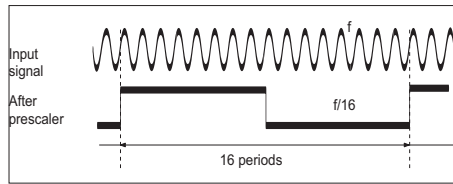

Figure 4-12 Divided-by-16 Prescaler

Prescalers do not reduce resolution in reciprocal counters. The relative quantization error is still: $\frac{250 \text{ ps}}{t_g}$.

The prescaling factors are as follows:

Function	Prescaling factor	
	PM6680B	PM6681
BURST A (160 MHz)	1	1
FREQ A (225/300 MHz)	2	4
FREQ A, negative slope (160 MHz)	1	1
FREQ B (160 MHz)	1	1
FREQ C (1.3 GHz)	256	512
FREQ C (2.7 GHz)	16	32
FREQ C (4.2 GHz)	32	64
FREQ C (4.5 GHz)	32	64
All other functions (160 MHz)	1	1

Note that a “SINGLE” cycle measurement in FREQ A measures two input cycles in the

PM6680B and four cycles in the PM6681. You can however force **FREQ A SINGLE** to measure on one input cycle by selecting negative trigger slope.

■ LF Signals

Signals below 50 Hz must be measured with manual triggering. When measuring pulses with a low repetition rate, for example, when you measure a 0.1 Hz pulse with a non-prescaled function like **PERIOD**, the measurement will require at least the duration of one cycle, that is 10 seconds, and at worst nearly 20 seconds. The worst case is when a trigger event took place just before the beginning of a measurement time (Figure 4-13). Measuring the frequency of the same signal will take twice as long, since frequency measurements prescale the signal by two.

Even if you have chosen a short measurement time, this measurement will require between 20 and 40 seconds.

■ HF Signals

As mentioned before, a prescaler in the C-input divides the input frequency before it is counted by the normal digital counting logic. The division factor is called prescaler factor and has a value of 16...512, see table on previous page. In PM6680B, equipped with a 2.7 GHz input, the factor is 16. That means that an input C frequency of, e.g., 1.024 GHz is transformed to 64 MHz.

Prescalers are designed for optimum performance when measuring stable continuous RF. Prescalers are not stable and would self-oscillate when there is no input signal present. To prevent a prescaler from oscillating, a “go-detector” is incorporated. The go-detector continuously measures the level of the input signal and simply blocks the

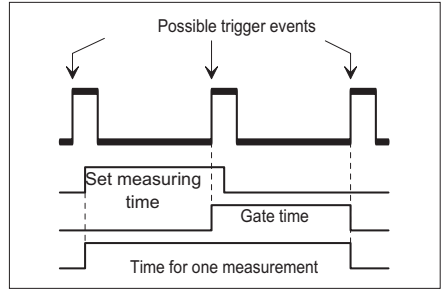

Figure 4-13 Measurement Time

prescaler output when no signal, or a signal that is too weak, is present.

Despite the counter’s ability to measure during

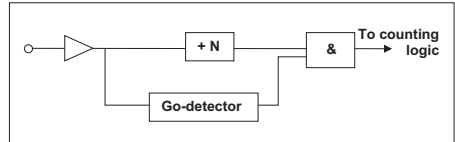

Figure 4-14 Go-detector in the prescaler

very short measurement times, the presence of a burst signal to be measured should be as follows:

$$\text{Min. burst} > (\text{presc. factor}) * (\text{inp. cycle time})$$

Time Measurements

Introduction

The base for all time interval measurements is to measure the time between a start and a stop condition. In addition to the basic Time A to B, the counters also offer Pulse Width and Rise/Fall-time measurements.

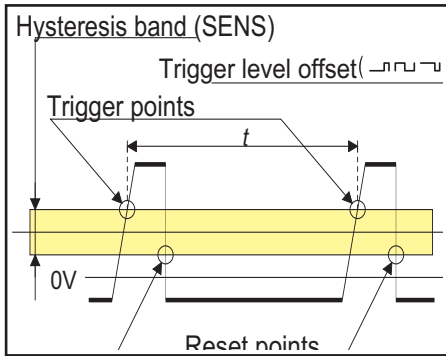

Figure 4-15 Time is measured between the trigger point and the reset point. Accurate measurements are possible only if the hysteresis band is narrow and centered around 50% of the amplitude.

Triggering

The set trigger level and trigger slope define the start and stop triggering.

If AUTO is on, the counter sets the trigger level to 50% of the signal amplitude, which is ideal for most time measurements.

■ Summary of Settings for Good Time Measurements:

- High signal level.
- Steep signal edges.
- AUTO ONCE, that is freezing the levels determined by AUTO, is normally the best choice when making time measurements.
- DC-coupling.
- 1X Attenuation.

TIME A-B

Measures the time between a start condition on the A-input, and a stop condition on the B-input.

Press SWAP if the start condition is on the B-input, and a stop condition on the A-input.

When the same (common) signal source supplies both start and stop trigger events, connect the signal to input A. Then make an internal interconnection of the input signal to both channels by pressing the COM A key.

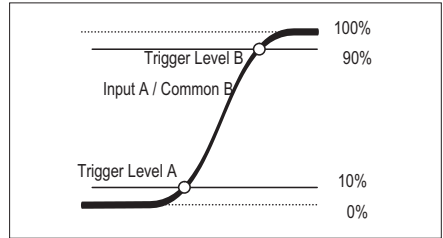

Figure 4-16 Trigger levels for rise/fall measurements.

P WIDTH A

The counter measures the pulse width on input A.

Press **SWAP** to measure the pulse with on input B.

—┐ gives positive pulse width.

—┘ gives negative pulse width.

The selected trigger slope is the start trigger slope. The counter automatically selects an inverse polarity as stop slope.

RISE/FALL A

The counter measures the time from when the signal passes 10% of its amplitude to when it passes 90% of its amplitude.

Rise and fall time can only be measured on input A. The counter automatically selects COM A and disables all B-input controls except SET B.

—┐ gives rise-time.

—┘ gives fall-time.

— **SET A** sets the low level (10%).

— **SET B** sets the high level (90%).

— **AUTO** sets the trigger levels to 10% and 90% of the signal level.

By convention, rise/fall-time measurements are made with the trigger levels set to 10%

(start) and 90% (stop) of the maximum pulse amplitude, see Figure 4-16. For ECL circuits, these levels are 20% (start) and 80% (stop), so for ECL, you must set manual trigger levels.

DUTY F A

Duty factor (or duty cycle) is the ratio between pulse width and period time. The counter determines this ratio by first making a pulse width measurement, then a period measurement, and calculating the duty factor as:

$$\text{Duty factor} = \frac{\text{Pulse width}}{\text{Period}}$$



This takes 2x the set measurement time.

—┐ gives positive duty factor.

—┘ gives negative duty factor.

Measurement Errors

Hysteresis

The trigger hysteresis, among other things, causes measuring errors, see Figure 4-17. Actual triggering does not occur when the input signal crosses the trigger level at 50 percent of the amplitude, but when the input signal has crossed the entire hysteresis band.

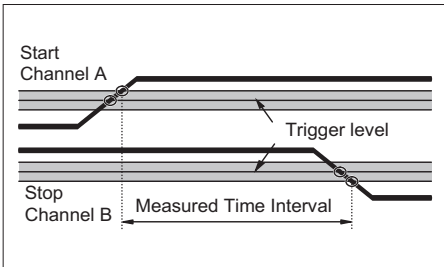

Figure 4-17 Trigger hysteresis

The hysteresis band is about 20 mV with attenuation 1X, and 200 mV with attenuation 1X.

To keep this hysteresis trigger error low, the ATTenuator setting should be 1X when possible. Use the 10X ATT position only when input signals have excessively large amplitudes or you need to set trigger levels higher than 5.1 V.

Overdrive and Pulse Rounding

Additional timing errors may be caused by triggering with insufficient overdrive, see Figure 4-18. When triggering occurs too close to the maximum voltage of a pulse, two phenomena may influence your measurement uncertainty: overdrive and rounding.

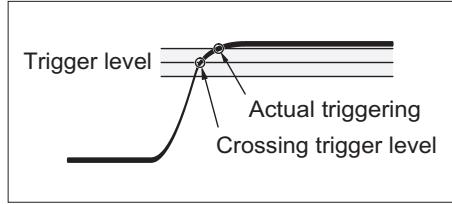

Figure 4-18 Insufficient overdrive causes Trigger Error.

Overdrive: When the input signal crosses the hysteresis band with only a marginal overdrive, triggering may take some 100 ps longer than usual. The specified worst case 500 ps (1 ns in the PM6680B) systematic trigger error includes this error, but you can avoid it by having adequate overdrive.

Rounding: Very fast pulses may suffer from pulse rounding, overshoot, or other aberrations. Pulse rounding can cause significant trigger errors, particularly when measuring on fast circuitry.

Auto Trigger

Auto Trigger is a great help especially when you measure on unknown signals. However, overshoot and ringing may cause AUTO to choose slightly wrong MIN and MAX signal levels. This does not affect measurements like frequency, but rise-time measurements may be affected.

Therefore, when working with known signals such as logic circuitry, set the trigger levels manually.

Always use manual trigger levels if the signal repetition rate drops below 100 Hz in the PM6680B, or below the lower frequency limit (the **Auto Lo** setting in the AUX MENU, see page 7-11) in the PM6681. The range in this case is 1 Hz to 50 kHz, and the preset value is 100 Hz.

Totalize

Totalize General

Totalize functions add up the number of trigger events on the counter inputs.

The AUX MENU provides additional totalize functions, such as totalize via input E and totalize measurements during a preset gate time.

TOT A–B MAN

This mode enables you to totalize (count) the number of trigger events on channel A. Start and stop of the totalizing is manually controlled.

If a second signal is simultaneously connected to input B, this mode totalizes the number of trigger events on A minus the number of trigger events on B.



When you only want totalization on A, disconnect lead on input B, to avoid miscounting from the subtracting B input (if you don't disable B via the AUX menu as described on the next page).

FUNCTION



Select TOT A MAN by pressing the FUNCTION key.

TOT ST/STOP



Start and stop the totalization manually by pressing the **TOT ST/STOP** key. Repetitive start/stops cause the counter to accumulate the number of events.

HOLD



Press **HOLD** to get an intermediate result without stopping the totalizing.

MEAS RESTART



Press the **RESTART** key when you want to reset the total sum to zero.



Manual trigger level settings must (normally) be used (unless >50 Hz pulse repetition rate).

■ Applications

The TOT A–B MAN makes it possible, for instance, to make differential flow measurements in control systems. Example: the number of cars in a parking lot equals the number of cars passing the entrance (A) gate, minus the ones passing the exit (B) gate.

■ Range

Counts to $2 * 10^9$ events at rates to 160 MHz.

TOT A MAN

Via the AUX MENU code entry (Code 8.11), it is also possible to select TOT A MAN, with input B disconnected. This optional mode also connects the A counting register in series with the B counting register to extend the counting capability to $1 * 10^{17}$ events.

To select Totalize A man with extended range, proceed as follows:

- Press the **FUNCTION** key to set the counter to the TOT A-B MAN mode.
- Press **AUX MENU**.
- Press the **SELECT** up or down key, until the display reads AU. CODES.
- Press **ENTER**.
- The F.PS* code displayed is now 8.12.
- Enter the value 8.11.
- Press **ENTER**.

* Function, Primary, and Secondary codes.

TOT A–B During a Preset Time

The counter counts trigger events on A minus trigger events on B during a preset gate time. Then it shows the result and starts a new measurement.

The gate time is selected with the TIME key, up to 400s. This function cannot use the shortest measurement times. If you set a short time,

the PM6680B will use 50 μ s gate time and the PM6681 will use 20 μ s.

This measurement resembles frequency measurement, which also totalizes input trigger events during a set measurement time. Unlike frequency measurements, the number of counted trigger events is not divided by the measurement time, but is immediately displayed.

If you need to control the start of this timed totalized measurement, press **HOLD** and then **RESTART** to initiate each new measurement.

To select timed totalize A-B, proceed as follows:

- Press the **FUNCTION** key until TOT A-B MAN is displayed.
- Press **AUX MENU**.
- Press the **SELECT** up or down key until the display reads AU. CODES.
- Press **ENTER**.
- The F.PS code displayed is now 8.12 where the channel selection defined PS.
- Enter the value 21.12.
- Press **ENTER**.
- Press **TIME**.
- Enter desired preset time.
- Press **ENTER**.
- For single measurements, select **HOLD** and press **RESTART** when you want to initiate a new measurement.



The 'Totalize A–B during a preset time' function derives the measurement start information, which causes the gate to open and the measurement timer to start, only from the primary measuring channel. This means that you cannot count exclusively on the subtracting channel. If you need to count on channel B only, you

must make B the primary channel by using the SWAP A-B key or by specifying the AUX CODE 21.22 or 21.21.

TOT A Start/Stop by B

Here the counter counts the number of pulses on the A-input. The totalizing is started by a pulse on B and stopped by the next pulse on B. After that the set measurement time has elapsed a new measurement is started, unless HOLD is on.

TOT A Gated by B

The counter counts pulses on the A-input for as long as the signal on the B-input is high. The total is reset and unless HOLD is on, a new measurement is started when the set measurement time has elapsed.

TOT A Gated by B Accumulated During a Preset Time

This function is the same as TOT A gated by B, except that the total is not reset between each gate pulse.

The time over which the counter accumulates single measurements can be set with the **TIME** key. This function cannot use the shortest measurement times. If you set a short time the PM6680B will use 50 μ s gate time and the PM6681 will use 20 μ s.

To select Totalize A gated by B accumulated, proceed as follows:

- Set the counter to the TOT A gated by B, with the **FUNCTION** key.
- Press **AUX MENU**.
- Press the **SELECT** up or down key, until the display reads **AV. CODES**.
- Press **ENTER**.
- The F.PS code displayed is now 10.12.
- Enter the value 20.12.
- Press **ENTER**.
- Press **TIME**.
- Enter desired time over which single measurements should be accumulated.
- For single measurements, press **HOLD** and press **RESTART** when you want to initiate a new measurement.

Phase

What is Phase?

Phase is the time difference between two signals of the same frequency, expressed as an angle.

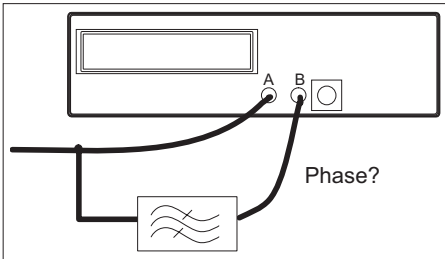

Figure 4-19 Phase delay.

The counter measures phase delay as two consecutive measurements. First a period measurement and immediately after that a time interval measurement. The period measurement is always made at the stop channel (B for Phase A-B and A for phase B-A). The phase delay is then mathematically calculated as:

$$\frac{360^\circ \times (\text{Time Interval } A - B)}{\text{Period } B}$$

or in other words:

$$\text{Phase } A - B = 360^\circ \times \text{time delay} \times \text{FREQ } B$$

Resolution

The frequency range for phase is 0 to 160 MHz and the result is always displayed with two decimals (resolution is always 0.01°).

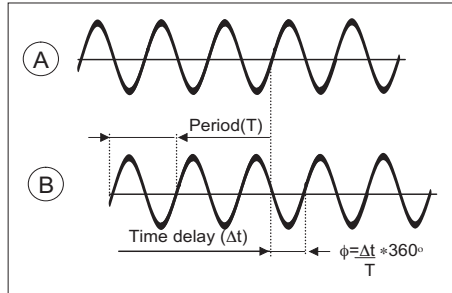

Figure 4-20 Phase definition.

Use SINGLE when measuring phase on signals <10 MHz, since averaging does not increase the number of digits. Use SINGLE, and you will avoid the problem with averaging signals with phase close to zero.



For the PM6681: you can calibrate the input amplifier hysteresis to minimize trigger errors in phase measurements. See Preventive Maintenance chapter, page 10-3.

Possible Errors

Phase can be measured on input signal frequencies up to 160 MHz. However at these very high frequencies, the phase resolution and range is reduced. The resolution for a single shot phase measurement is:
 $50ps \times 360^\circ \times FREQ$ (PM6681)

$250ps \times 360^\circ \times FREQ$ (PM6680B)

For averaged measurements, the resolution is:

$$\frac{50}{\sqrt{N}} ps \times 360^\circ \times FREQ$$

(limit at $1ps \times 360^\circ \times FREQ$)

$$\frac{250}{\sqrt{N}} ps \times 360^\circ \times FREQ$$

(limit at $100ps \times 360^\circ \times FREQ$)

Since the phase delay is a time interval measurement, with a maximum attainable resolution of 1 ps, the resolution at 160 MHz is:
 $(1ps \times 360^\circ \times 160MHz) \approx 0.06^\circ$

At 500 kHz, for example, the phase resolution in the PM6681 using SINGLE measurements is:

$$(50ps \times 360^\circ \times 500MHz) \approx 0.01^\circ$$



Always turn on SINGLE when measuring phase below 100 kHz. The counter always presents the phase angle with 2 decimals regardless of measurement time, so there is no need for long measurement times. Use the statistical function "MEAN" instead if you need more digits.

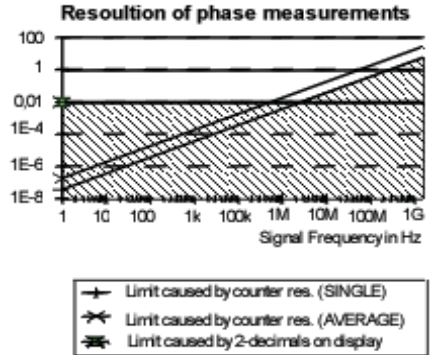

Figure 4-21 Phase resolution.

The LSD of the display is fixed at 0.01° , which means that the display itself limits the resolution for frequencies below 100 kHz and shows too much information at frequencies above 100 kHz. Phase measurements are often made at lower frequencies, and systematic error normally contributes more than random errors. For the sake of simple and unambiguous readout, we chose to display a fixed format of 0.01° .

■ Measuring Phase Close to 0

Phase measurements from A-B can be made from 0° and upwards, whereas Phase B-A measurements range from slightly above 0° . This difference is caused by a built-in delay line of approximately 3 ns; see Figure 4-23.

Using average can cause problems if the result is close to zero. Even a single result that is below zero will ruin the averaged result.

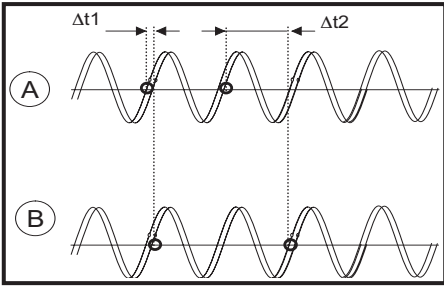

Figure 4-23 When the signal jitters and the phase is close to zero, t can jitter between 0 and the time for one period. Averaging such results will give erroneous results.

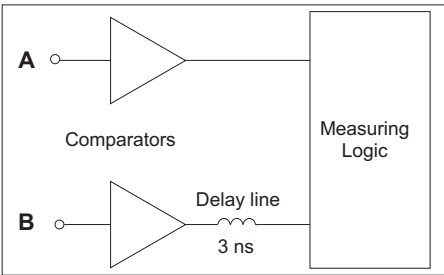

Figure 4-22 Input B delay line improves phase.

This delay line assures correct measurements when start and stop occur simultaneously at the BNC-inputs, that is 0° phase delay. The counter mathematically compensates for this delay before it displays the result, so the delay does not influence the accuracy of the measurement; however, it influences the measurement range.

As a consequence, the maximum measurable phase delay is not exactly 360°, but slightly below 360°. The reason, once again, is the 3 ns delay, which would treat, for instance, a 359.9° phase as -0.1°, when measuring at high frequencies. Since the delay is fixed and the

input signal period depends on the input signal frequency, the phase range is frequency dependent. See the following table.

Range: 0° to 360°* (1 - (3 ns * FREQ))	
160 MHz	0° to 180°
100 MHz	0° to 250°
10 MHz	0° to 350°
1 MHz	0° to 359°
100 kHz	-180° to 359.9°
10 kHz*) and below	-180° to 359.99°

Table 4-1 The relationship between phase range and input frequency

* Any theoretical range improvement below 10 kHz is “drowned” in the fixed 0.01° display resolution.

The A and B input can be swapped to also measure Phase B-A. This phase range is also frequency dependent, for example:

Range B-A: (3ns × 360° × FREQ) to 360°

■ **Some examples:**

At 160 MHz, the B-A range is 180° to 360°, at 1 MHz the B-A range is 1° to 360° and below 10 kHz, the B-A range is 0.01° to 360°.

In normal phase measurements using lower frequencies (below 10 kHz), there are in practice no range restrictions, and both Phase A-B and Phase B-A cover -180° to 360°. But for very high frequencies, you must take care to select the proper function. For instance at 160 MHz, the ranges are not even overlapping; Phase A-B covers -180° to 180°, whereas Phase B-A covers 180° to 360°.

Inaccuracies

The inaccuracy of Phase A-B measurements depends on several external parameters:

- Input signal frequency
- Peak amplitude and slew rate for input signals A and B
- Measurement time
- Input signal S/N-ratio

Some internal parameters are also important:

- Internal time delay between channel A and B signal paths
- Variations in the hysteresis window between channel A and B

Let us look deeper into the restrictions and possibilities of using phase measurements.

Inaccuracy: The measurement errors are of two kinds:

- Random errors
- Systematic errors

The *random errors* consist of resolution (quantization) and noise trigger error. These can be significantly reduced by averaging over a long measurement time. In practice, these random inaccuracies do not set the limit *if the measurement time is long enough*.

Systematic errors consist of “inter-channel delay difference” and “trigger level timing” errors. Systematic errors are constant for a given set of input signals, and in general, you can compensate for them in the controller (GPIB-systems) or via MATH (manual operation).

■ Random Errors

The Phase quantization error algorithm is:

$$\frac{50 \text{ ps} \times \text{FREQ} \times 360^\circ}{\sqrt{N}}$$

“N” is the number of samples in averaged measurements. For LF-signals up to 12 kHz, $N = \text{FREQ} \times (\text{meas.time})$. For high frequency signals, $N = 2000s^{-1} \times (\text{meas.time})$. For instance a 1 MHz input signal and an 8.3 ms measurement time, “N” is 100; thus, the quantization error is:

$$\left(\frac{50 \text{ ps} \times 1 \times 10^6 \times 360^\circ}{\sqrt{100}} \right) \approx 0.002^\circ$$

And for the same 1 MHz input signal in a *single-shot* measurement, “N” is 1; thus, the quantization error is:

$$\frac{50 \text{ ps} \times 1 \times 10^6 \times 360^\circ}{1} \approx 0.02^\circ$$

The Trigger noise error consists of *start* and *stop* trigger errors that should be added. Each error, for sine shaped input signals, is:

$$\frac{360^\circ}{\sqrt{N} \times 2 \pi \times S/N \text{ ratio}}$$

Let’s use an example of a noisy signal that has a S/N-ratio of 40 dB. This corresponds to an amplitude ratio of 100 times (and power ratio of 10000 times). Using the values from the above example, a 1-MHz signal and either an 8.3 ms measurement time or a single shot measurement:

$$\frac{360^\circ}{\sqrt{100} \times 2 \pi \times 100} = 0.06^\circ$$

(averaged over 8.3 ms)

$$\frac{360^\circ}{\sqrt{1} \times 2 \pi \times 100} = 0.6^\circ \quad (\text{single shot})$$

The sum of random errors should not be added linearly, but in an “RMS-way”, because of their random nature. Let’s do so for our examples above.

Random error =

$$\sqrt{\text{quant. err.}^2 + \text{start trg. err.}^2 + \text{stop trg. err.}^2}$$

$$\sqrt{0.002^2 + 0.06^2 + 0.06^2} \approx 0.08^\circ \text{ (averaged over 8.3 ms)}$$

$$\sqrt{0.02^2 + 0.6^2 + 0.6^2} \approx 0.8^\circ \text{ (single-shot)}$$

The conclusion is that the quantization error and trigger noise error can be reduced by averaging over many periods. Compared with the LSD displayed, 0.01° , these errors can be ignored. That is, the random error can usually be reduced to 0.01° for low and medium-high frequencies, with a sufficiently long measurement time.

What about random errors caused by internal amplifier noise? Internal noise contribution is normally negligible. The phase error caused by noise on the signal, whether internal or external, is:

$$\frac{360^\circ}{2\pi \times \frac{S}{N} \text{ ratio} \times \sqrt{N}}$$

For an input signal of 100 mVrms and the typical internal noise figure of 100 μ V rms gives us a S/N-ratio of a minimum of 60 dB (1000 times). This gives us a worst case error of 0.06° for single shot measurements. By measuring over 30 cycles, the error decreases to

0.01° . Increasing the input signal to 0.6V gives the same result.

■ Systematic Errors in Phase Measurements

Systematic errors consist of 3 elements:

- Inter-channel propagation delay difference.
- Trigger level timing error, due to trigger level uncertainty.
- Trigger level timing error, due to hysteresis, (PM6680B only).

The third error element is negligible in the PM6681, due to hysteresis compensation.

The “inter-channel propagation delay difference” is typically 300 ps at identical trigger conditions in both input channels. Therefore, the corresponding Phase difference is:

$$<0.3 \text{ ns} \times 360^\circ \times \text{FREQ}$$

See the following table.

160 MHz	17°
100 MHz	11°
10 MHz	1.1°
1 MHz	0.11°
100 kHz	0.011°
10 kHz and below ¹	0.001°

Table 4-2 Phase difference caused by inter-channel propagation delay difference

¹ Any theoretical range improvement below 10 kHz is “drowned” in the fixed 0.01° display resolution.

The “trigger level timing error” is depending on two factors:

- The actual trigger point is not exactly zero, due to hysteresis. The trigger point could differ between channels A and B.
- The two signals have different slew rates at the zero-crossing.

Every counter has an input hysteresis. This is necessary to prevent noise to cause erroneous input triggering. The width of the hysteresis band determines the maximum sensitivity of the counter. It is approximately 30 mV. This means that when you set a trigger level of 0 Volt, the actual trigger point would normally be +15 mV and the recovery point –15 mV.

This is also the case in the PM6680B. The difference in trigger points between channels is ±2.5 mV typically, that is actual triggering is expected to take place typically between 12.5 mV and 17.5 mV.

Trigger level timing error in the PM6681

This counter has a hysteresis compensation built-in, meaning that the microcomputer can offset the trigger level so that actual triggering (after offset) equals the set trigger level (before offset). This general hysteresis compensation is active in phase as well as in time interval and rise/fall time measurements. There is a certain residual uncertainty of a few mV and there is a certain temperature drift of the trigger point. For Phase measurements there exists a special *phase calibration* routine, that is invoked via AUX MENU and automatically performed. This was described earlier on page . The nominal trigger point immediately after calibration is 0V with an uncertainty of ± 2.5 mV. Since the trigger point will have a temperature drift, it is advised to calibrate phase directly before the measurement. The uncer-

tainty over the full temperature range is ±4 mV.

A sine wave expressed as

$$V(t) = V_p \times \sin(2\pi ft), \text{ has a slew rate } \frac{\Delta V}{\Delta t}$$

$V_p \times 2\pi f$ close to the zero-crossing. That gives us the systematic time error when crossing 2.5 mV, instead of crossing 0 mV.

$$\frac{2.5 \text{ mV}}{(V_p \times 2\pi \times \text{FREQ})} \text{ (s)}$$

And the corresponding phase error in degrees is:

$$\frac{(2.5 \text{ mV} \times 360^\circ \times \text{FREQ})}{(V_p \times 2\pi \times \text{FREQ})}$$

which can be reduced to:

$$\frac{0.15V}{V_p} (^\circ)$$

This error can occur on both inputs, so the worst case systematic error is thus:

$$\frac{0.15}{V_p(A)} + \frac{0.15}{V_p(B)} (^\circ)$$

Vpeak (A)	Vpeak (B)	Worst case systematic error
150 mV	150 mV	1°+1°=2°
1.5 V	150 mV	0.1°+1°=1.1°
1.5 V	1.5 V	0.1°+0.1°=0.2°

Table 4-3 Systematic trigger level timing error (examples) in the PM6681.

Trigger Level Timing Error in the PM6680B

The systematic error has a third component, due to uncompensated hysteresis, i.e., trigger-

ing on nominal 15 mV instead of 0 mV. This is an important error source when the input signals have different slew rates, and thus cross the hysteresis band with different speed. Even with equal zero-level crossing, a signal with less slew rate reaches 15 mV in a longer time than a high slew rate signal.

A sine wave expressed as

$$V(t) = V_p \times \sin(2\pi ft), \text{ has a slew rate } \frac{\Delta V}{\Delta t} \text{ of}$$

$V_p \times 2\pi f$ close to the zero-crossing. That gives us an additional systematic time error when crossing 15 mV, instead of crossing 0 mV.

$$\frac{15mV}{(V_p(A) \times 2\pi \times FREQ)} - \frac{15mV}{(V_p(B) \times 2\pi \times FREQ)} \text{ (s)}$$

And the corresponding phase error in degrees is:

$$\frac{(15mV \times 360^\circ)}{(2\pi \times V_p(A))} - \frac{(15mV \times 360^\circ)}{(2\pi \times V_p(B))}$$

which can be reduced to:

$$\frac{0.9}{V_p(A)} - \frac{0.9}{V_p(B)} \text{ (}^\circ\text{)}$$

With identical A and B input signals, the error is 0.000°

Just as in the PM6681, there is an uncertainty in the actual trigger level of ±2.5 mV. This part of the systematic trigger level timing error is significant when the input signals are equal.

This systematic error is also dependent on the input signal amplitude:

$$\frac{(2.5mV \times 360^\circ)}{(2\pi \times V_p(B))} + \frac{(2.5mV \times 360^\circ)}{(2\pi \times V_p(A))}$$

which can be reduced to:

$$\frac{0.15}{V_p(B)} + \frac{0.15}{V_p(A)} \text{ (}^\circ\text{)}$$

The total error in is:

$$\left(\frac{0.9}{V_p(A)} - \frac{0.9}{V_p(B)}\right) + \left(\frac{0.15}{V_p(B)} + \frac{0.15}{V_p(A)}\right) \text{ (}^\circ\text{)}$$

Vpeak (A)	Vpeak (B)	Worst case systematic error
150 mV	150 mV	(6°-6°)+1°+1°=2°
1.5 V	150 mV	(6°-0.6°)+0.1°+1°=6.5°
1.5 V	1.5 V	(0.6°-0.6°)+0.1°+0.1°=0.2°

Table 4-4 Systematic trigger level timing error (examples) in the PM6680B.

■ Method for Compensation:

Systematic errors can be largely compensated for by connecting the same signal, that is later to be measured, to both counter inputs A and B via a power splitter and read out the Phase. The result should be zero, but shows instead the systematic error

1. Systematic Time Delay Error:

Connect the signals to be measured to both counter inputs A and B via a power-splitter. Set both inputs to AC coupling, 50 Ω termination, positive slope, and 0.00 V trigger level.

Select the measuring function “Phase A-B”, select 1s measurement time, and read the display. Use this difference from 0° to correct future phase readings.

2a. Systematic Trigger Level Timing Error in the PM6680B:

Before (or after) the actual phase measurement, measure $V_{\max}(A)$ and $V_{\max}(B)$. Use these voltage values to compensate the phase readout according to the following formula:

$$\text{correction} = + \frac{0.9}{V_{\max}(A)} - \frac{0.9}{V_{\max}(B)}$$

2b. Systematic Trigger Level Timing Error in the PM6681:

To minimize the errors in phase and other measurements where it is essential to trigger exactly, the hysteresis compensation of the input amplifier should be calibrated. Read about how to do this in the preventive maintenance chapter on page 10-3.

3. Residual Systematic Error:

By mathematically (on the bench or in the controller) applying both corrections above, the systematic error will be reduced, but not fully eliminated. The residual time delay error will be negligible, but the trigger level error will remain to a certain extent because the actual trigger point (approx. +15 mV) can differ between input channels A and B, although they are designed to be identical.

Voltage

V_{MAX} V_{MIN}

The counter can measure the input voltage levels V_{MAX} and V_{MIN} on DC-input voltages and on repetitive signals between 1 Hz and 100 MHz, (100 Hz to 100 MHz in the PM6680B). The voltage capacity is -50 to +50 V in two automatically selected ranges. A high speed voltage mode can be selected via the AUX MENU. This mode measures voltage twice as fast but it reduces the frequency range to between 10 kHz and 120 MHz.

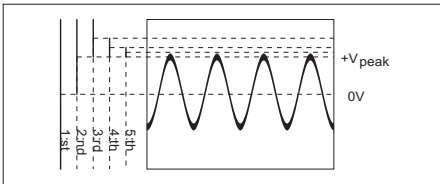

Figure 4-24 The voltage is determined by making a series of trigger level settings and sensing when the counter triggers.

For LF-signals the measurement has “voltmeter performance” (that is an accuracy of about 1% of the reading). Voltage measurements can be made up to 100 MHz.

V_{PP}

The display shows V_{MIN} and V_{MAX} side by side. If you want V_{PP} instead, you (or the timer/counter) must calculate V_{PP} as the difference between V_{MIN} and V_{MAX}.

*HINT: If you have a voltage max/min reading on the display and you want it as V_{PP}, press **MATH** and press **SELECT/SET** until math is ON and $(K \cdot X + L) / M$ is selected; confirm by pressing **ENTER**. If the constants K, L, and M are set to their default values 1, 0, and 1, the display will show V_{PP}. Note also that the function display now has changed from VOLT A MAX/MIN to just VOLT A.*

V_{PP} is available as a separate function, but it can only be reached from the GPIB-interface.

V_{rms}

When the shape (sine, pulse) of the input signal is known, half the crest factor can be set as the constant K in the mathematical function. The display will then show the actual V_{rms} value of the input signal.

*EXAMPLE: A sine wave has a crest factor of 0.707 ($\frac{\sqrt{2}}{2}$). Press **K=** and enter*

0.354 via the **DATA ENTRY** keys. Confirm by pressing **ENTER**. Check that the L and M constants are set to their default settings 0 and 1. Press **MATH** and **SELECT/SET** until math is ON and (K*X+L)/M is selected; confirm by pressing **ENTER**. If the input is AC coupled and VOLT A selected, the display will now show the rms value of any sine wave input.

If the sine wave is superimposed on a DC voltage, the rms value is found as: $0.354 \cdot V_{PP} + V_{DC}$. If V_{DC} is not known it can be found as:

$$V_{DC} = \frac{V_{MAX} - V_{MIN}}{2}$$

To display the rms value of a sine wave superimposed on a DC voltage, follow the example above, but set L= to the DC voltage.

Gated Voltage

The voltage measurement functions (V_{MAX}, V_{MIN}, V_{PP} and trigger levels) are measured by detecting the peak values. The time when the voltage should be measured can be qualified by means of a signal on the E or B input (only the E-input in PM6681). The measurement is enabled as long as this signal is high (when positive polarity is selected). This can be used to “remove” parts of the signal, for example overshoots or undershoots on pulses.

Gated voltage is selected in the AUX MENU (code 3004.X). Select input B (PM6681) or input E (PM6680B or PM6681) and polarity with the ARM STOP key. ARM STOP cannot be used with gated voltage.

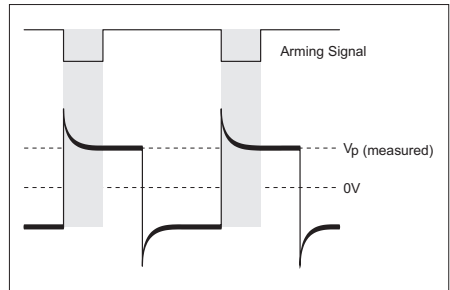

Fig 4-25 Overshoots and undershoots on the signal are not measured when Gated Voltage is selected.

Calibration

To minimize the errors in voltage measurements, the hysteresis compensation of the PM6681 input amplifier should be calibrated. Read about how to do this in the preventive maintenance chapter on page 10-2.

This page is intentionally left blank.

Chapter 5

Measurement Control

About This Chapter

This chapter explains how you can control the start and stop of measurements and what you can obtain by doing that. The chapter starts by explaining the keys and the functions behind them, then gives some theory, and ends with actual measurement examples.

Measurement Time

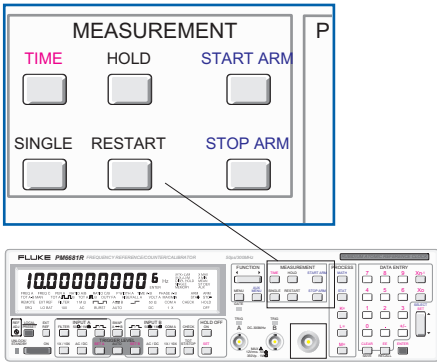

TIME



The measurement time is preset to 200 ms. This gives 10 digits on the display, and 4 to 5 measurements each second.

Increasing the measurement time gives more digits, but fewer measurements per second.

To change the measurement time:

- Press the **TIME** key.
- Increase/decrease the value by pressing the **SET ▲ / ▼** key.
- (On the PM6681 you can also use the **◀FUNCTION▶** key).
- Confirm your selection by pressing **ENTER** or by pressing the **TIME** key again.

The measurement time changes in 1/2/5 steps in its continuous range and in discrete steps for the fastest range.

Range for the PM6680B: 800 ns to 400 s.

The range is divided into a continuous section between 50 μs and 400 s and a discrete section with the following steps: 800 ns, 1.6 μs, 3.2 μs, 6.4 μs, and 12.8 μs. Preset measurement time is 200 ms.

Range for the PM6681: 80 ns to 400 s.

The range is divided into a continuous section between 20 μs and 400 s and a discrete section with the following steps: 80 ns, 160 ns, 320 ns, 640 ns and 1.28 μs. Preset measurement time is 200 ms.



*If you select **SINGLE**, the measurement time becomes the Display Time (time between measurements).*



*To quickly select the lowest measurement time, Press **TIME**, then **0** and **ENTER**. The counter will show **Err. RANGE** and suggest its minimum time. Press **ENTER** to accept.*

■ Fine-Tuning the Measurement Time

For times in the continuous range, you can set your own measurement time as follows:

- Press **TIME**.
- Enter the new measurement time via the keyboard. Then press **ENTER** to confirm the selection. (On the PM6681 you can also press the **TIME** key again.)

Gate Indicator

The GATE LED is on when the counter is busy counting input cycles.

SINGLE

SINGLE



When **SINGLE** is on, the counter shows the results from a single measurement cycle.

When **SINGLE** is off (default setting), the counter makes an average measurement over the set measurement time.

Use **SINGLE** when you want to measure single-shot phenomena or when you just want fast results without the need for many digits.

The number of input periods in a **SINGLE** measurement depends on the prescaler factor of the input and which function is selected as follows:

Frequency A measurements: The result is the average of two consecutive periods.

Duty factor Phase measurements: The counter does a composite measurement (one period and one pulse width).

Totalize A measurements: This is always a single measurement.

Frequency B, Period A, Pulse Width A Ratio, A/B measurements: The result is from one period.

Frequency C measurements: The HF-input prescaling factor sets the number of periods used to 16.

SINGLE is not relevant for V_{max} , V_{min} .

Display Hold

HOLD



Pressing **HOLD** completes current measurement and freezes the result on the display.

RESTART



RESTART initiates a new measurement.

Arming

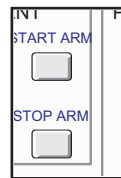

Arming gives you the opportunity to start and stop a measurement when an external qualifier event occurs.

Start and stop of the arming function can independently be set to positive slope, negative slope, or it can be turned off.

Input E on the rear panel is the normal arming input, but also input B can be used.

Arming is somewhat complicated, so use the examples later in this chapter to see what you can obtain by using it. There is normally no need to use arming other than with complex signals (noncontinuous wave).

Start Arming

START ARM Start arming acts like an EXT TRIGGER on an oscilloscope. It allows the start of the actual measurement to be synchronized to an external trigger event.



In a complex signal, you may want to select a certain part to perform measurements on. For this purpose, there is an arming delay function, which delays the actual start of measurement with respect to the arming pulse, similar to a “delayed timebase” in an oscilloscope. You can choose to delay start arming by a preset time, or by a preset number of events.

■ Activate Start Arming as Follows:

- Press **START ARM**;
- Select *OFF POS* or *NEG* and press **ENTER**.

■ Switch on delay

- Press **AUX MENU**; select *Ar. Start* with the **SELECT** key, and press **ENTER**.
- Select *Chan. E* or *Chan. B* with the **SELECT** keys and press **ENTER**.
- Select *DELAY OFF*, *DELAY Cnt* or *DELAY t. i.* with the **SELECT** keys and press **ENTER**.
- If you enabled delay, enter the delay time or event counts using the **DATA ENTRY** keys, and press **ENTER**.

Start arming can be used for all functions except BURST, PRF and VOLT. If you use start arming to arm an average measurement, it only controls the start of the first sample.

Stop Arming

STOP ARM Stop arming prevents the stop of a measurement until the counter detects a level shift on the E input. Combining Start and Stop Arming results in an “external gate” function which determines the duration of the measurement.



■ Activate Stop Arming as Follows:

- Press **STOP ARM**;
- Select *OFF POS* or *NEG* and press **ENTER**.

■ Switch on Delay

- Press **AUX MENU**, select *Ar. Stop* with the **SELECT** key, and press **ENTER**.
- Select *Chan. E* or *Chan. B* with the **SELECT** keys, and press **ENTER**.
- Select *DELAY OFF*, *DELAY Cnt* or *DELAY t. i.* with the **SELECT** keys, and press **ENTER**.
- If you enabled delay, enter the delay time or count using the **DATA ENTRY** keys. End by pressing **ENTER**.

Stop arming can be used for: FREQUENCY, PERIOD, RATIO, and TOTALIZE.

Digit Blanking

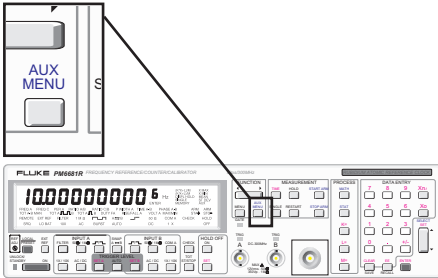

AUX MENU



Blanking switches off unnecessary digits on the display.

9.9170-----⁵Hz *Five digits are blanked in this example.*

- Press **AUX MENU**.
- Select **bl Rn. d iL It** with **SELECT** and confirm by pressing **ENTER**.
- Enter the number of digits you want blanked and confirm by pressing **ENTER**.

To turn off blanking, enter 0 as No. of blanked digits.

■ Two Methods to Reduce the Number of Digits

Reading a 10-digit display when you don't need more than five or six digits takes more time than necessary.

Reducing the measurement time gives fewer digits on the display. However, it also means that each result is shown for a shorter time, with more display updates per second. If the display is to be easy to read, it should not be updated more than a few times per second as

with the default measurement time, which gives four to five display updates each second.

Digit blanking on the other hand, decreases the number of digits on the display without increasing the display update frequency. It makes it possible to switch off any number of digits between zero and ten. This means that the number of digits displayed is zero to ten less than as calculated by the counter's truncation algorithm.

More Digits

These counters can accurately measure up to 12 digits, even though the display cannot show more than 10 digits simultaneously.

In the PM6681 about 1s measurement time gives a resolution of 11 digits and about 10s gives 12 digits.

The PM6680B needs about 2s for 11 digits, and 20s for 12 digits.

Showing 12 digits is not meaningful unless you have an external reference frequency with an accuracy that justifies a readout of more than 10 digits.

■ Offset the Display with MATH

To display additional least-significant digits at the cost of most-significant digits, you must offset the display value. For instance when a measured frequency reads:

9.99812345678⁰Hz

It is possible to subtract 9.99E^{+6} via the MATH function. After subtraction, the displayed value is: 8.12345678³Hz

If you must display both the two most-significant and the two least-significant digits, you just switch the MATH function off for displaying the MSD's and on for the LSD's.

Controlling Measurement Timing

The Measurement Process

Basic Free-running Measurements

Since these counters use the reciprocal counting technique, they always synchronize the start and stop of the actual measuring period to the input signal trigger events. A new measurement automatically starts when the previous measurement is finished (unless HOLD is on). This is ideal for continuous wave signals.

The start of a measurement takes place when the following conditions have been met (in order):

- The counter has fully processed the previous measurement.
- If the counter makes SINGLE measurements, the display time (=set measurement time) must have expired.
- All preparations for a new measurement are made.
- The input signal triggers the counter's measuring input.

The measurement ends when the input signal meets the stop trigger conditions. That happens directly after one of the following events:

- The set measurement time has expired (in frequency measurements, for example).
- In SINGLE, the measurement stops immediately when the input signal fulfils the stop trigger conditions (which is normally when it passes the trigger window the second time).

Measurement Time and Rates

The set measuring time decides the length of a measurement in all average types of measurements. In a *single-shot* type of measurement, however, the measurement time acts as a “display time” setting. For example, if a measurement time of 500 ms is set in a *single period* measurement, and the period is 100 ns, the measurement will take 100 ns, then the display will show the result for 500 ms before the next measurement can start.

This is important to know when you want to make fast measurements, for example, when using statistics or want fast measurements on the GPIB bus.



To get a high measuring speed, it is not enough to set the counter for single-cycle measurements. You should also set the measurement time to the minimum value.

The so-called “dead time”, that is the time between the stop of one measurement and the start of the next one, can be well below 1 ms in free-running mode if you do the following:

- Do not use AUTO.
- Do not use MATH.
- Switch off the display via GPIB.

Additional controls over start and stop of measurements

Free-running measurements may be easy to understand, but measurements can get more complex.

Besides input signal triggering, the *start* of a measurement is further controlled by the following elements:

- Manual **RESTART**, if Display Hold is selected.
- GPIB triggering (<GET> or *TRG), if bus triggering is selected.
- External arming signal, if Start Arming is selected.
- Expired start arming delay, if Arming Delay is selected.

In addition to expired measurement time and stop signal triggering, the *stop* of measurement is further controlled by:

- External arming signal triggering, if Stop Arming is selected.

GPIB triggering is described in the Programming manual.

Resolution as Function of Measurement Time

The quantization error and the number of digits on the display mainly define the resolution of the counter, that is the least-significant digit displayed.

As explained on page 4-11 under Reciprocal Counting, the calculated frequency f is:

$$f = \frac{n}{t_g}$$

while the relative rms quantization error = $\pm 250\text{ps}/t_g$ in the PM6680B and $\pm 50\text{ps}/t_g$ in the PM6681.

The counter truncates irrelevant digits so that the rms quantization resolution cannot change the LSD (least-significant digit) more than ± 5 units. This occurs when the displayed value is 99999999, and the quantization error is worst case. The best case is when the displayed value is 10000000. Then the quantization resolution corresponds to ± 0.5 LSD units.



± 1 unit in 99999999 (=1E8) means 10 times more relative resolution than ± 1 unit in 10000000 (=1E7), despite the same number of digits.

A gradual increase of the measurement time reduces the instability in the LSD caused by the quantization uncertainty. At a specific measurement time setting, the counter is justified to display one more digit. That one additional digit suddenly gives ten times more display resolution, but not a ten times less quantization uncertainty. Consequently, a measurement time that gives just one more display digit shows more visual uncertainty in the last digit.

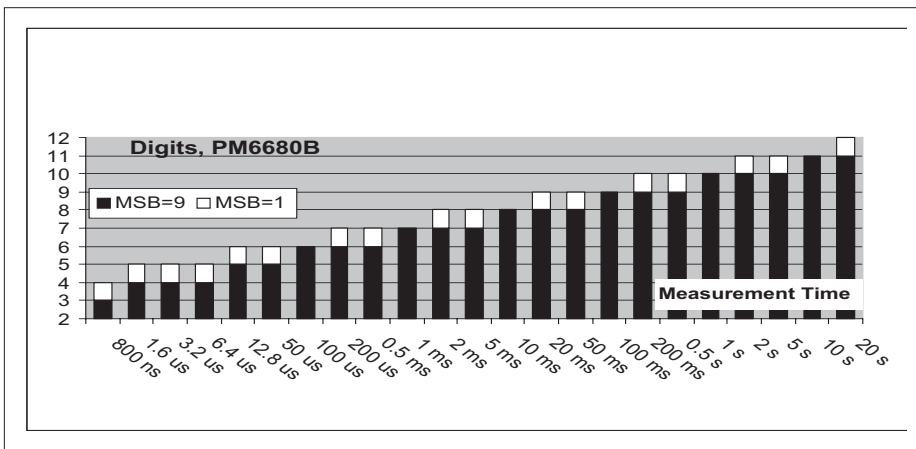

Figure 5-1 Resolution as a function of measurement time for a 10 MHz frequency measurement. Note that the same measurement time gives one more digit if the most significant digit is 1, than if it is 9.

For a stable LSD readout, the maximum measurement time selected should be one that still gives the required number of digits. Such optimization of the measurement time enables the total resolution to be equal to the quantization resolution. This is shown in as a function of the selected measurement time.

Now let's look deeper into the concept of *arming*.

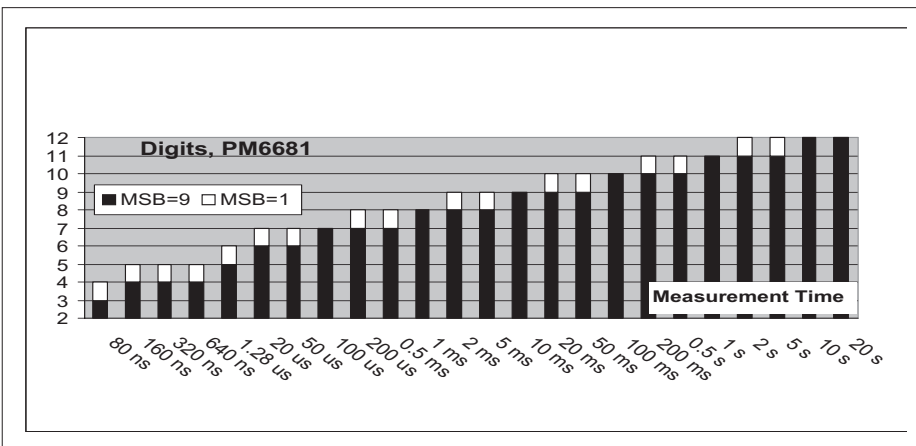

Figure 5-2 Resolution as a function of measurement time for frequency measurements.

What is Arming?

Arming is a pretrigger condition (“qualifier”) that must be fulfilled before the counter allows a measurement to start. The pretrigger condition can be compared to using a gun. When you use a gun, you must first *arm* the gun before you can pull the *trigger*.

Arming can also be used to qualify the stop of a measurement. This is called “stop arming” as opposed to the more common “start arming.”

When you use arming, you disable the normal free-run mode, i.e. individual measurements must be preceded by a valid start arming signal transition.

If you use start arming and stop arming together you get an externally controlled measurement time, a so-called “External Gate”.

■ Manual Arming

The counters have a manual start arming function called **DISPLAY HOLD**. Here you manually arm the start of each individual measurement by pressing the **RESTART** key.

Use this manual arming mode to measure single-shot phenomena, which are either triggered manually or occur at long intervals. Another reason for using this manual arming could simply be to allow sufficient time to write down individual results.

■ When Do I Use Start Arming?

Start arming is useful for measurements of frequency in signals, such as the following:

- Single-shot events or non-cyclic signals.
- Pulse signals where pulse width or pulse positions can vary.
- Burst signals.

- Signals with frequency variations versus time (“profiling”).
- A selected part of a complex waveform signal.

Signal sources that generate complex waveforms like pulsed RF, pulse bursts, TV line signals, or sweep signals, usually also produce a *sync* signal that coincides with the start of a sweep, length of an RF burst, or the start of a TV line. These sync signals can be used to arm the counter. See Figure 5-3.

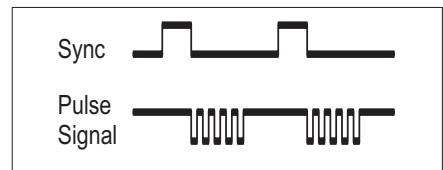

Figure 5-3 A synchronization signal starts the measurement when start arming is used.

■ When Do I Use Stop Arming?

You normally use stop arming together with start arming. That means that the external gating signal controls both the start and the stop of the measurement. Such a gating signal can be used to force the counter to measure the frequency of a pulsed RF signal. Here the position of the external gate must be inside a burst. See Figure 5-4.

In time interval measurements, you can use the stop arming signal as a sort of “external trigger Hold Off signal.” Here you block stop triggering during the external period. See Figure 5-5.

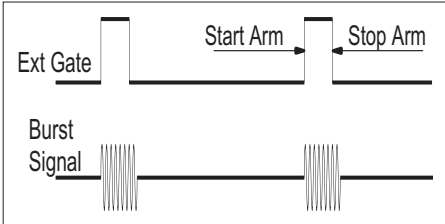

Figure 5-4 Start and stop arming together is used for burst signal gating.

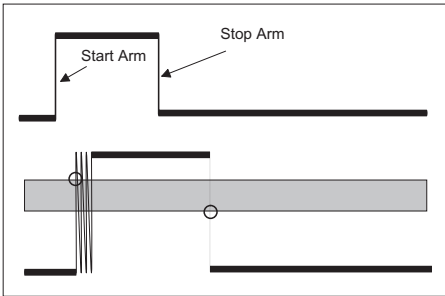

Figure 5-5 Using arming as an external Hold Off.

■ The Arming Input

– **Input E** is the default arming input. This input is suitable for arming (sync) signals that have TTL levels. The trigger level is fixed at 1.4V and cannot be changed. The trigger slope can be set to positive or negative.

– **Input B** can be used as arming input for all single channel measurements and dual channel measurements where the arming signal is one of the measuring signals. This input is more suitable if your arming signal does not have TTL levels. All B-input controls such as AC/DC, trigger level, 50Ω etc. can be used to condition the arming signal.

Using the measurement signal as arming signal

If arming is to be based on the signal to be measured, use input B as arming input. You can connect the signal directly to input B or route the signal to input B also, using **COM A**.

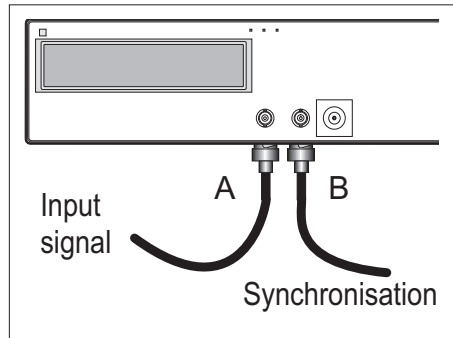

Figure 5-6 Separate arming and measuring signals.

When performing time or frequency measurements in complex signals having a unique trigger point, input B arming and COM A can be used to make the measuring signal itself “auto-arm” the counter, e.g., to measure the frequency of an input signal, when it has reached a specified voltage limit (= set trigger level), see Figure 5-5.

■ When Do I Use Arming With Delay?

You can delay the start (or stop) arming point with respect to the arming signal. Use this function when the external arming signal does not coincide with the part of the signal that you are interested in.

The range for time delay is 200 ns to 1.67 seconds with a setting resolution of 100 ns.

■ Getting The Whole Picture

The flowchart in Figure 5-8 illustrates how *arming a trigger hold off* enables precise control of the start and stop of the actual measurement when you operate the counter from the front panel. If you use the counter via the GPIB, read more about bus arming and triggering under the heading “How to use the trigger system” in the Programming Manual.

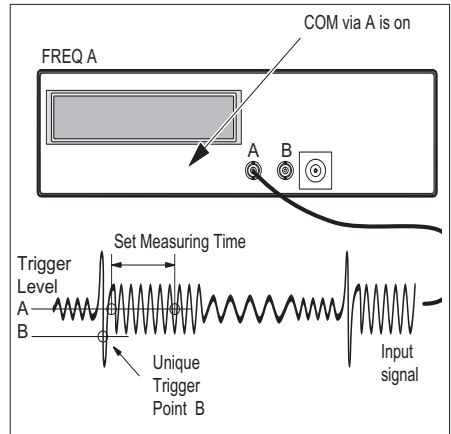

Figure 5-7 Auto-arm using the trigger level on B as a qualifier.

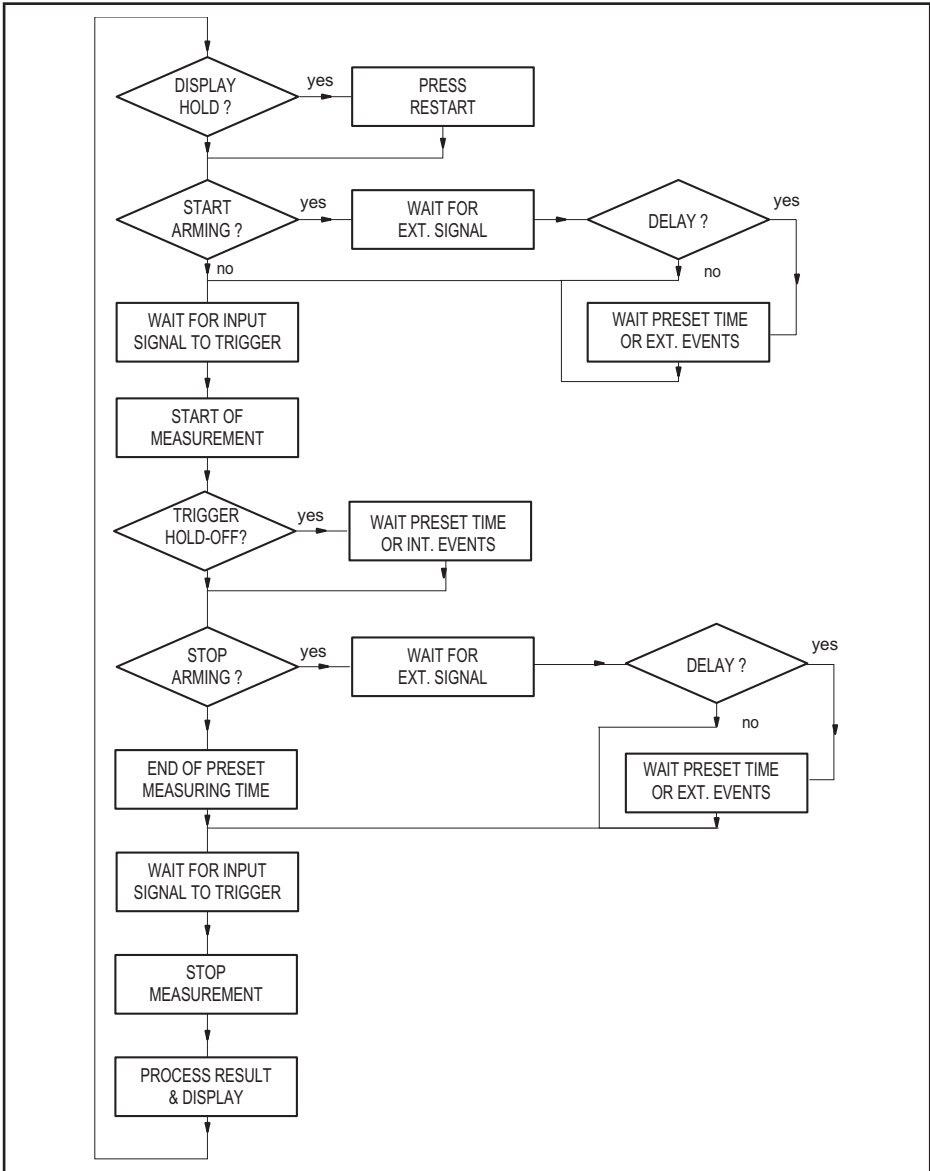

Figure 5-8 Measurement control flow diagram.

Arming Setup Time

The arming logic needs a setup time of about 5 nanoseconds before the counter is really armed; see Figure 5-9.

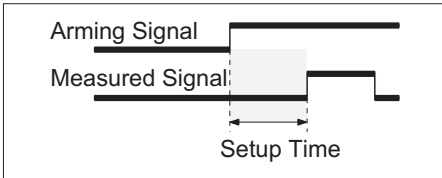

Figure 5-9 Time from active external control edge until measurement is armed:
E channel . < 5 ns

When arming delay is selected, the setup time is different; see Figure 5-10. It illustrates the effect of the 100-ns delay resolution.

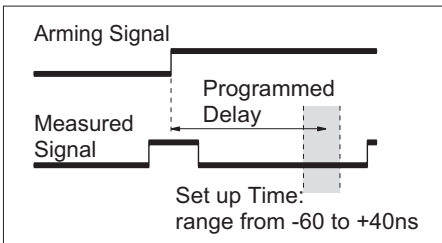

Figure 5-10 Time from expired time delay until measurement is armed:
. -60 to +40 ns.

Figure 5-10 shows that a start trigger signal may be detected although it appears 60 nanoseconds before the programmed time delay has expired. The start trigger signal must come 40 nanoseconds after the programmed time delay has expired to guarantee correct start of the measurement.

Setup times for event count delays are shown in the following figures:

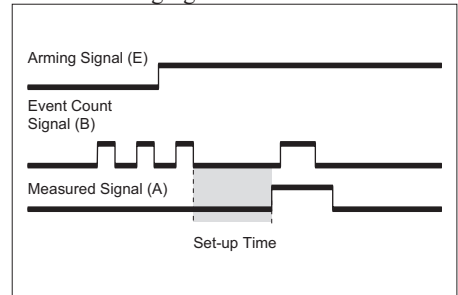

Figure 5-11 Time from expired event delay until measurement is armed: typ 40 ns.

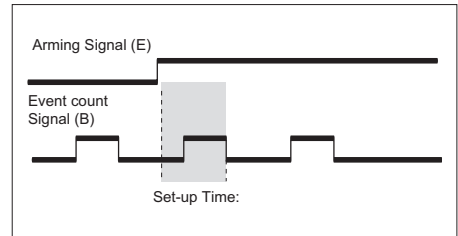

Figure 5-12 Time from active arming edge to first "countable" event: typ 22 ns.

Arming Examples

Introduction to Arming Examples

The following arming examples are available:

#1 Measuring the first pulse in a burst

#2 Measuring the second pulse in a burst

#3 Measuring the third pulse in a burst

#4 Measuring the time between pulse #1 and #4 in a burst

#5 Measuring frequencies in two-tone bursts

#6 Measure the frequency in a short RF-burst

#7 Profiling

Exmples 1 to 4 measure the pulse width of a selected positive pulse in a burst. You can, however, also measure the period, rise time, or duty factor by changing FUNCTION, and you can measure on a negative pulse by changing trigger slope.

Seeing is believing

It always feels safer if you see which pulse you are measuring. The gate monitor output can be connected to an oscilloscope together with the burst and the sync pulse. When the counter triggers correctly you will see a faint flicker at the measured pulse. A suitable measurement setup is shown on the next page.

The gate monitor signal is not continuously repetitive since it follows the action inside the counter; this is why it flickers on the screen, but don't worry, the position of the gate pulse is what is interesting, not its intensity.

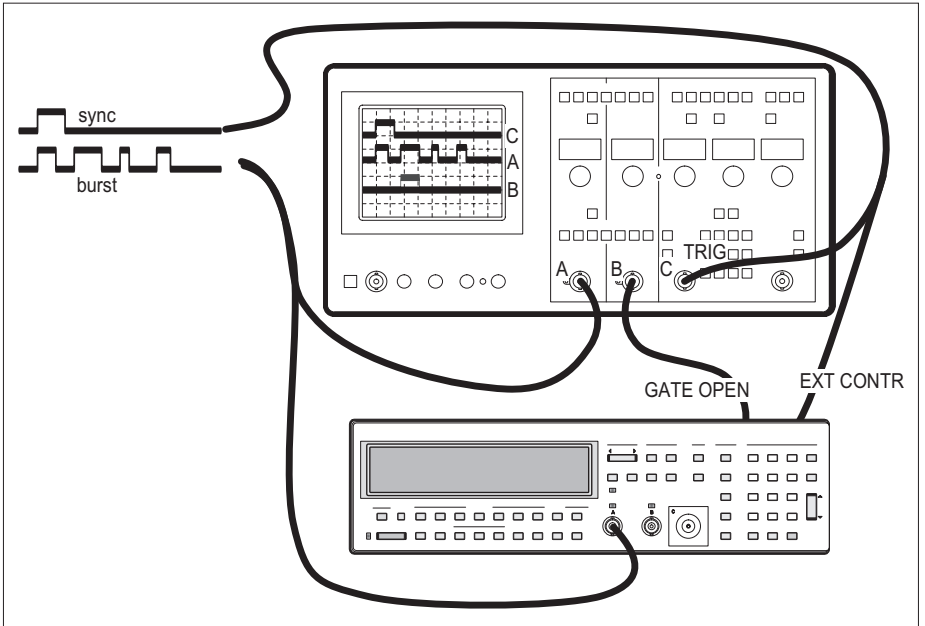

Figure 5-13 Connect like this if you want to see which pulse you are measuring.

#1 Measuring the First Burst Pulse

In the first example we will measure the width of pulse #1 in a repetitive pulse burst. In this example, a synchronization signal (SYNC) with TTL levels is also available. See Figure 5-14.

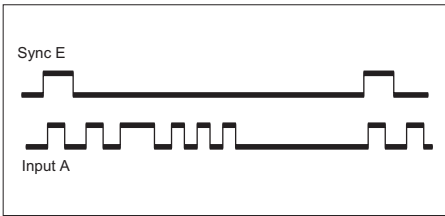

Figure 5-14 Synchronizing the measurement so that the pulse width of the first pulse is measured.

Our task is to synchronize the start of the measurement (start trigger) to the leading edge of the first pulse. Depending on the signal timing, this can be easy, difficult, or very difficult.

■ A. Auto Synchronization Without Arming

If we are lucky, we can manage without using the arming function at all. Often, the counter can automatically synchronize the measurement start to the triggering of the first pulse. The conditions for success are that the pulse burst does not repeat itself more than 50 to 150 times per second. The duration of a pulse burst (between first and last pulse) must be substantially less than the distance to the next burst.

Do the following steps to perform auto synchronization without arming:

- Connect the burst signal to input A.
- Adjust the manual sensitivity and trigger level until the burst signal triggers the counter correctly.
- Use the **FUNCTION** key to select Pulse Width.
- Select **SINGLE** measuring mode.
- Press **MEAS TIME** and set a measurement time according to the following text.

The measurement time setting can be used for synchronization purposes. The preset measurement time does not influence the actual measurement time in single interval measure-

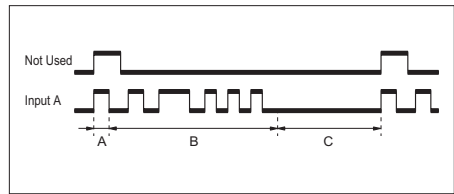

Figure 5-15 A= Measure
 B= Process time + display time(=set measurement time) minimum 3 to 4 ms
 C= Waiting for next input signal trigger event.

ments, but it will influence the time between measurements. If you select a measurement time that almost equals the duration of a burst, the auto-synchronization will work.

If the repetition rate is too high, synchronization will not be guaranteed, but there is a high probability that auto-synchronization will work anyway. However, occasional erroneous values will be displayed. To achieve guaranteed synchronization, use the Start Arming function.

■ B. Synchronization Using Start Arming

The SYNC signal can be directly used to arm the measurement. This requires that the leading edge of the SYNC signal occurs more than 5 nanoseconds before the leading edge of the first pulse in the burst. See Figure 5-16.

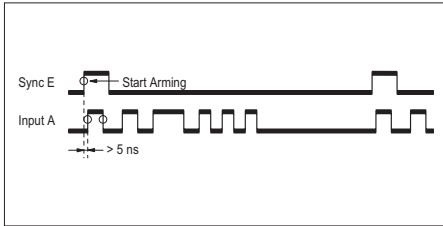

Figure 5-16 Synchronization using start arming.

Do the following steps to perform synchronization using start arming:

- Connect SYNC to input E.
- Connect the burst signal to input A.
- Set a trigger level that makes the burst signal trigger the counter correctly.
- Press **ARM START**, select **Ar. Start POS**, and press **ENTER**.
- Use **FUNCTION** to select P Width A.
- Press **TIME** and set a short measurement time.
- Select **SINGLE** and measure.

If there is no (or too little) time difference between the arming signal and the first pulse in the pulse burst, arming must be combined with a delay. See example c.

■ C. Synchronization Using Start Arming With Time Delay

If the pulse bursts have a stable repetition frequency, you synchronize the measurement using Start Arming with Time Delay. Here you

use the SYNC pulse belonging to a preceding burst to synchronize the start of measurement. Set the time delay to a time longer than the duration of a pulse burst and shorter than the repetition time of the pulse bursts. See Figure 5-17.

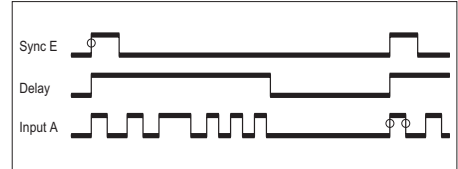

Figure 5-17 Synchronization using start arming with time delay.

Do the following steps to start signal synchronization using start arming with time delay:

- Connect SYNC to input E.
- Connect the burst signal to input A.
- Set a trigger level that makes the burst signal trigger the counter correctly.
- Press **ARM START**, select **Ar. Start POS**, and press **ENTER**.
- Press **AUX MENU**, select **Ar. Start**, press **ENTER**.
- Select **Chan E** press **ENTER**.
- Select **DELAY t. t.** and press **ENTER**.
- Enter a suitable delay, and confirm by pressing **ENTER**.
- Use **FUNCTION** to select P Width A.
- Press **TIME**, and set a short measurement time.
- Select **SINGLE**, and measure.

#2 Measuring the Second Burst Pulse

The next task is to measure the width of the *second* pulse in the pulse train from example 1. How can we now synchronize the measurement start to the start of the second pulse? In this case auto-synchronization, without the use of the arming function, cannot work.

Auto-synchronization can be used only to synchronize on the *first* trigger event in a burst.

Depending on the SYNC signal's position relative to the burst, and the duration of the SYNC signal, the measurement can be performed with or without using arming delay.

If the trailing edge of the SYNC signal occurs *after* the leading edge of the first pulse but *before* the second pulse in the pulse burst, then normal start arming without delay can be used. In this case:

- Connect SYNC to input E.
- Connect the burst signal to input A.
- Select triggering on positive slope on input A.
- Adjust the trigger level with **SET A** until the burst signal triggers the counter correctly.
- Press **ARM START**, select **AR. StA NEG**, and press **ENTER**.
- Use **FUNCTION** to select P Width A.
- Use **TIME** to set a short measurement time.
- Select **SINGLE** and measure.

This example is shown in the following figure.

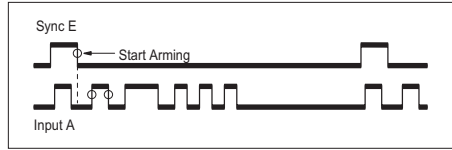

Figure 5-18 *If the trailing edge of the sync signal appears before the second pulse, use arming without delay.*

If the SYNC-pulse timing is not so suitable as in the above measurement example, then arming must be used combined with a time delay; see the following figure. The set delay time must be set to expire in the gap between pulse #1 and #2.

- Connect SYNC to input E.
- Connect the burst signal to input A.
- Select triggering on positive slope on input A.
- Adjust the trigger level with **SET A** until the burst signal triggers the counter correctly.
- Press **ARM START**, select **AR. StA POS**, and press **ENTER**.
- Press **AUX MENU**, select **Ar. StArt**, Press **ENTER**.
- Select Chan E press **ENTER**.
- Select **dELAY t i.** and press **ENTER**.
- Enter a suitable delay via keyboard, confirm by pressing **ENTER**.
- Use **FUNCTION** to select P Width A.
- Use **TIME** to set a short measurement time.
- Select **SINGLE** and measure.



ARM START delayed by events cannot be used here since the minimum delay is 2 events. See also example #3 on the next page.

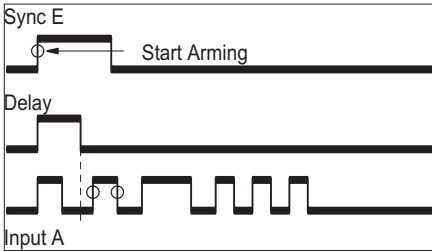

Figure 5-19 *Use arming with delay if the trailing edge of the sync signal appears too late to be useful.*

#3 Measuring the Third Burst Pulse

The task now is to measure the width of the *third* pulse in the pulse train from example 1. How can we now synchronize the measurement start to the start of the third pulse? Not surprisingly, auto-synchronization, without the use of the arming function, cannot work in this case either.

A delayed arming, with a time delay that expires somewhere between the second and the third pulse, will work. This measurement is almost identical to the previous one, where we delayed the arming until the second pulse arrived. For the sake of completeness, this example is shown below.

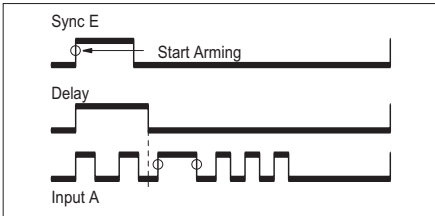

Figure 5-20 *Measuring the third pulse in a burst using delay by time.*

An alternative is to specify the delay as a number of input B trigger events instead. Hence, the measuring input signal itself determines the delay, and not the internal timer circuit. The minimum number of trigger events that can be set as a delay is 2. The maximum is $2^{24}-1$. This means that the width of pulse number 2 cannot be measured using this delay method, since there must first appear at least two trigger events (i.e., pulses) until the counter is armed; however, this method is a convenient way of measuring the width of pulse number 3, 4, 5, etc.

This event count delay is useful when the pulse positions can vary. Independent of when pulse #3 occurs, it can be identified and its width can be measured.

- Connect the burst signal to input A.
- Select triggering on positive slope on input A.
- Press **COM A** to also feed the signal to the B-channel.
- Adjust the trigger level with **SET A** and **SET B** until the burst signal triggers the counter correctly.
- Press **ARM START**, select **Ar. StA POS**, and press **ENTER**.
- Press **AUX MENU**, select **Ar. StArt**, press **ENTER**.
- Select **ChAn E** press **ENTER**.
- Select **dELAY Cnt.** and press **ENTER**.
- Enter the value 2 via keyboard, confirm by pressing **ENTER**.
- Use **FUNCTION** to select P Width A.
- Use **TIME** to set a short measurement time.
- Select **SINGLE** and measure.

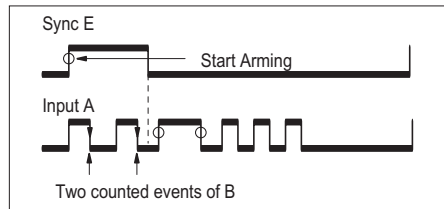

Figure 5-21 *Using delay by events to measure the third pulse in a burst .*

#4 Measuring the time between burst pulse #1 and #4

In the previous examples, the synchronization task has been to identify the *start* of a measurement and to perform a single-shot time interval measurement. Now, we will complicate the picture even more. In our next example we will not only arm the start, but also the stop of a measurement. We will measure the time between the first and the fourth pulse in the pulse burst. We still have the SYNC signal available, see Figure 5-22.

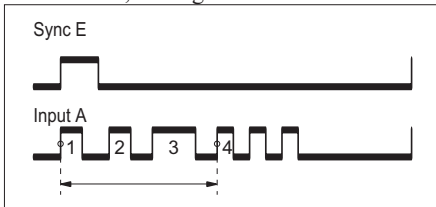

Figure 5-22 Measuring a time interval inside a burst.

The measurement function is not pulse width, but time interval between positive slopes on channels A and B. The desired start and stop trigger points are marked in the preceding illustration. Our task is now to arm both the start and the stop of this measurement. The start arming is already described in example #1, i.e., synchronize measurement start to the leading edge of the first pulse. The challenge is to synchronize the *stop* of the measurement, i.e., to arm the stop. If we do nothing, the time interval measured will be the time between the first and the second pulse. We must thus delay the stop. This can be done in different ways.

A. Using Trigger Hold Off to Delay the Stop a Certain Time

Trigger Hold Off is used to inhibit stop triggering during a preset time. The Hold Off period starts synchronously with the start trigger event. The Hold Off time should be set to expire somewhere between pulse number 3 and 4. See Figure 5-23.

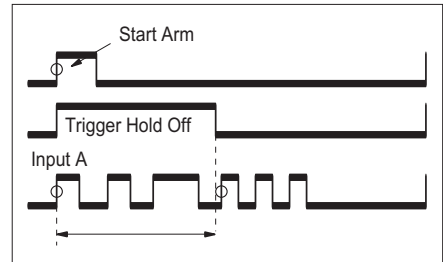

Figure 5-23 If Hold Off expires between pulse three and four, the correct time interval is measured.

- Connect SYNC to input E.
- Connect the burst signal to input A.
- Press **COM A** to also feed the signal to the B-channel.
- Use **FUNCTION** key to select TIME A-B.
- Press **SINGLE** to switch off averaging.
- Set a short measurement time.
- Set input A trigger level and positive slope.
- Set input B trigger level and positive slope.
- Press Hold Off **ON** to activate Hold Off.
- Press the HOLD OFF **SET** key and enter a suitable delay via the **DATA ENTRY** keys, confirm by pressing **ENTER**.
- Set start arming conditions according to example #1 (if needed).
- Measure.

B. Using Trigger Hold Off to Delay the Stop by Three Trigger Events

Alternatively, the Hold Off delay can be expressed as a number of trigger events on input B instead of a preset time. In this case the delay should be three stop trigger events. Since the measuring input signal is already connected to input B (through COM via A), this method is practicable if no arming start delay is needed.

Remember: You cannot combine time delayed arming with event count delayed Hold Off.

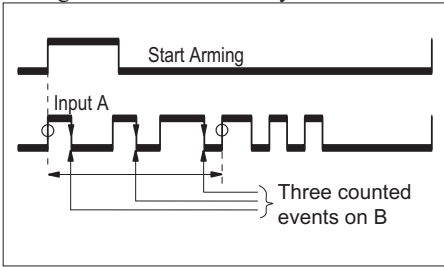

Figure 5-24 Using Hold Off by events to disable triggering during three pulses.

- Connect SYNC to input E.
- Connect the burst signal to input A.
- Press **COM A** to feed the signal also to the B-channel.
- Press **FUNCTION** to select Time Interval A-B.
- Press **SINGLE** to switch off averaging.
- Set a short measurement time.
- Set input A trigger level and positive slope.
- Set input B trigger level and positive slope.

PM6680B

There is no special menu where you can set Hold Off delay by events, so you have to use the Stop Arming menu.

- Press **AUX MENU**, select **Ar. StOP** and press **ENTER**.
- Use **SELECT/SET** to select **CHAn. E** and press **ENTER**.
- Use **SELECT/SET** to select **DELAy Cnt** and press **ENTER**.
- Enter **2** (or more) events, and press **ENTER** to exit AUX MENU. (The digit here is not used in this measurement but if you enter 1, the delay by counted events will be switched off).
- Switch on Hold Off and press the Hold Off **SET** key.
- Enter the digit **3** via the keyboard.
- Set start arming conditions according to example 1 (if needed).
- Measure.

PM6681

- Switch on Hold Off and press the Hold Off **SET** key.
- Select **H. OFF Cnt** and press **ENTER**.
- Enter the digit **3** via the keyboard.
- Set start arming conditions according to example 1 (if needed).
- Measure.

C. Using Stop Arming (i.e., External Hold Off) to Delay the Stop

So far in our examples, the sync signal has been used exclusively as a start arming signal; i.e., we have been concerned only about the leading edge of the sync signal, and not its duration. However, the sync signal can

also be used as an *External Trigger Hold Off* when you select stop arming on the trailing edge of the sync signal. If the duration of the sync pulses can be externally varied, we can select a duration that expires in the gap between pulse numbers 3 and 4.

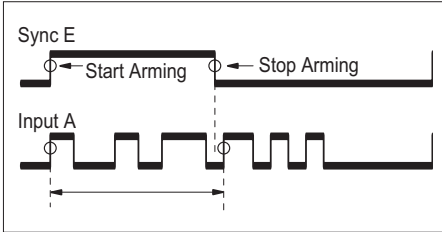

Figure 5-25 Using both start and stop arming to select the part of the burst that is of interest.

Then proceed as follows:

- Connect SYNC to input E.
- Connect the burst signal to input A.
- Press **COM A** to also feed the signal to the B-channel.
- Use **FUNCTION** to select TIME A-B.
- Select **SINGLE**.
- Set a short measurement time.
- Set input A trigger level and positive slope.
- Set input B trigger level and positive slope.
- Press **ARM STOP**, select **Ar. Sto NEG**, and press **ENTER**.
- Set start arming conditions according to example 1 (if needed).
- Measure.

#5 Measuring Frequencies in Two-Tone Bursts

Sonar bursts can consist of two different frequencies with different durations. See Figure 5-28.

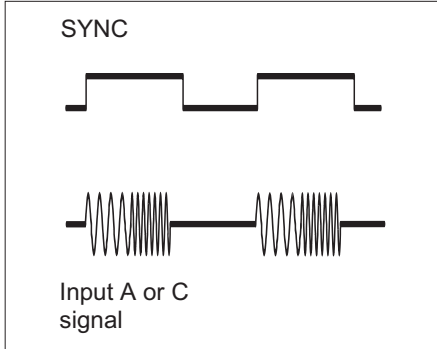

Figure 5-26 A two-tone burst with its sync-pulse.

Measuring the frequency of the first part is normally no problem.

Because of the reciprocal measurement, the counter automatically synchronizes the measurement with the start of the burst.

For fool-proof synchronization, start arming can be used, as in Figure 5-26. The measurement time should, of course, be short enough.

To measure the frequency of the second half requires the use of arming delay. The delay time should be set to a value slightly longer than the duration of the first tone in the two-tone burst. See Figure 5-27.

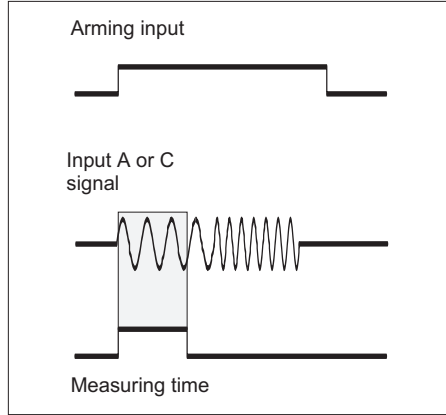

Figure 5-27 Autosync or external arming makes it possible to measure the first tone in the burst.

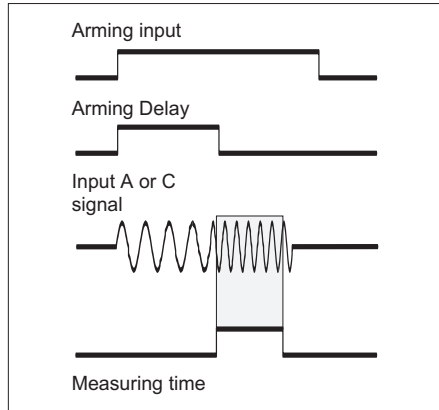

Figure 5-28 Add a delay to the External arming, and the second tone can be measured.



Note that arming delay can be used without any external sync. Just use the measured signal itself as arming signal on input B (select COM VIA A), and set the delay as usual in the AUX MENU.

#6 Measure the Frequency in a Short RF-Burst

To measure the frequency of RF-bursts shorter than 2ms on the C-input, you must have an external sync-signal.

The 1.3 and 2.7 GHz C-input prescalers self-oscillate in the gap between two bursts (when no signal is present). A go-detector normally blocks this self-oscillation, but this go-detector also stops short bursts from reaching the counter circuits.

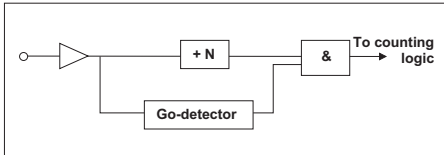

Figure 5-29 Go-detector in the prescalers.

The go-detector is *automatically* disabled as soon as start arming has been activated.

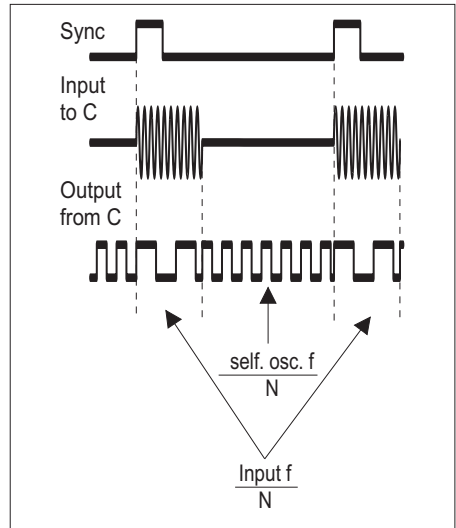

Figure 5-30 The prescaler self-oscillates between the external sync. pulses. N = the prescaling factor.

■ Avoid Disturbance From Self-Oscillations

It takes some time for the prescaler to stop self-oscillating and start to sync on the input signal. To avoid measuring on the self-oscillation, delay the start of the measurement by pressing AUX MENU and setting Arm Start Channel C delay to:

$$(> 2 \times \text{prescaling factor} \times \text{period})$$

Example:

For instance, when measuring 1 GHz burst frequencies using the 2.7 GHz input C in PM6680B, the delay time should be $> 2 \times 16 \times 1 \text{ ns} = > 32 \text{ ns}$. Thus, the minimum delay of 200 ns is OK.

#7 Profiling

Profiling means measuring frequency versus time. Examples are measuring warm-up drift in signal sources over hours, measuring the linearity of a frequency sweep during seconds, VCO switching characteristics during milliseconds, or the frequency changes inside a “chirp radar” pulse during microseconds. These counters can handle many profiling measurement situations with some limitations. Profiling can theoretically be done manually, i.e., by reading individual measurement results and plotting in a graph. However, to avoid getting bored long before reaching your 800th or so measurement result, you must use some computing power and a GPIB interface. In profiling applications, the counter acts as a fast, high resolution sampling front end, storing results in its internal memory. These results are later transferred to the controller for analysis and graphical presentation. The TimeView software package greatly simplifies profiling.

You must distinguish between two different types of measurements called *free-running* and *repetitive sampling*.

■ Free-Running Measurements

Free-running measurements are performed over a longer period, e.g., to measure the stability over 24 hours of oscillators, to measure initial drift of a generator during a 30-minute warm-up time, or to measure short-term stability during 1 or 10s. In these cases, measurements are performed at intervals from 140 μs (PM6681) or 500 μs (PM6680B) and upwards. In other words, the maximum sampling rate is

7 kHz or 2 kHz resp. There are several different ways of performing the measurements at regular intervals.

Single-cycle measurements using measurement time setting for “pacing”

When single measurements are set on the counter, the measurement time acts as a “measurement hold time”. By setting the measurement time to 10s for example, single-cycle measurements are automatically made at 10s intervals.

Using a controller as “pacer”

With fairly large intervals such as seconds between individual samples, the timer in the controller can be used for pacing the individual measurements.

Using external arming signals

External arming signals can also be used for “pacing.” For example with an arming signal consisting of 10 Hz pulses, individual measurements are armed at 100 ms intervals.

Letting the counter run free

When the counter is free-running, the shortest delay between measurements is approximately 140 μs (PM6681) or 500 μs (PM6680B) plus set measurement time. For example, when a measurement time of 2 ms is set in the PM6680B, the time between each sample is approximately 2.5 ms. You have to perform some special actions over the GPIB in search of that high speed, for instance blanking the display. This is described in the Programming Manual.

■ Repetitive Sampling Profiling

The measurement setup just described will not work when the profiling demands less than 140 μs intervals between samples.

How to do a VCO step response profiling with 100 samples during a time of 10 ms, i.e., 100 μs between samples.

This measurement scenario requires a *repetitive* input step signal, and you have to repeat your measurement 100 times, taking one sample per switch period. And every new sample should be delayed 100 μs with respect to the previous one.

This is easiest controlled by a controller, although it is possible but tedious to manually set and perform all 100 measurements.

The following are required to setup a measurement:

- A repetitive input signal (e.g., frequency output of VCO).
- An external SYNC signal (e.g., step voltage input to VCO).
- Use of arming delayed by a preset time (e.g., 100, 200, 300 μs).

See Figures 5-31 and 5-32.

When all 100 measurements have been made, the results can be used to plot frequency versus time. Note that the absolute accuracy of the time scale is dependent on the input signal itself. Although the measurements are *armed* at 100 $\mu\text{s} \pm 100 \text{ ns}$ intervals, the actual *start of measurement* is always synchronized to the first input signal trigger event after arming.

TimeView will do this measurement quick and easy, see Chapter 8.

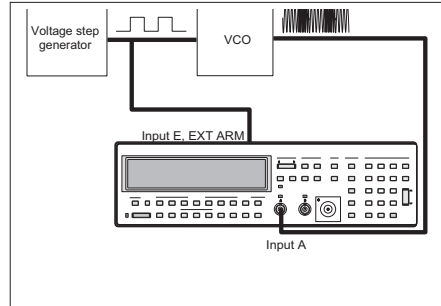

Figure 5-31 Setup for transient profiling of a VCO.

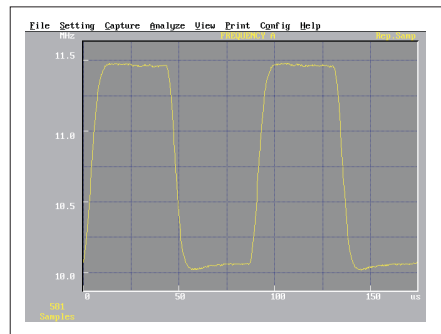

Figure 5-32 Results from a transient profiling measurement.

This page is intentionally left blank.

Chapter 6

Process

Introduction

Three different ways to process a measuring result are available: Averaging, Mathematics and Statistics. They can be used separately or all together.

Averaging

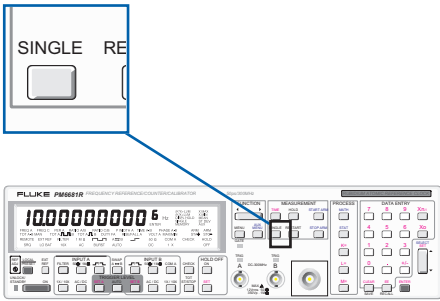

SINGLE



If **SINGLE** is turned off, the counter makes a multiple period average. That means that it averages all data captured during the set measuring time and displays the result.

Sample Size for Average

Average in time interval measurements can be determined by sample size or measuring time. Average time interval is used in Time-, Rise/Fall-, Phase, Duty factor, and Pulse Width measurements.

Normally, the measuring time determines the number of samples averaged (N):

$$N = \text{Repetition rate (Hz)} \times \text{Measuring time}$$

$$(f \leq 12 \text{ kHz, PM6681})$$

$$(f \leq 2 \text{ kHz, PM6680B})$$

or

$$N = 12000 \times \text{Measuring time (PM6681)}$$

$$N = 2000 \times \text{Measuring time (PM6680B)}$$

Sample size N can also be set directly via the AUX menu.

If the Sample Size is set to 1000, the result is averaged from 1000 consecutive measurements. Preset value is 100.

Press **AUX MENU** and press **SELECT** until the display shows: **t 1. AVG. COUNT**.

Press **ENTER** to enter the sub-menu. You can now turn on or off sample size for time interval. Use the **SELECT/SET**-key to toggle between ON/OFF, and confirm your selection by pressing **ENTER**.

If ON is selected, you will be asked for a value of the sample size. Enter a value via the keyboard. The Sample Size can be a value within the range 0 to 65535. Confirm your selection by pressing **ENTER** and the timer/counter exits Auxiliary menu and continues to measure.

If OFF is selected, the timer/counter exits Auxiliary Menu and returns to measuring mode.

Mathematics

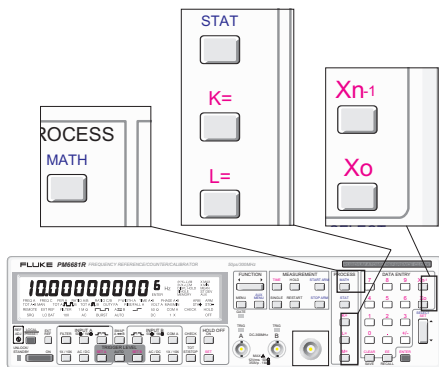

MATH



The counter can use two mathematical expressions to process the measurement result: $(K \cdot X + L) / M$ or $((K/X) + L) / M$.

K, L and M are user selectable constants, and X is the measurement result. To select a mathematical expression, press the **MATH** key. Use the **SELECT/SET** key to step up/down until the display shows the expression you want to use, and confirm by pressing **ENTER**.

K=



K, L, and M are constants used for Mathematical processing.

L=



M=



To enter a constant:

- Press the key for the constant you want to change (**K**, **L** or **M**).
- Enter the value on the keyboard.
- Press +/- if you want a negative constant.
- Confirm by pressing **ENTER**.

The constants are stored until you reset them, or enter another constant. After a PRESET the constants are K=1, L=0, M=1.

Xn-1



These functions can be used as the constants K, L and M within a mathematical formula.

Xo



Both Xn-1 and X0 can be used in the same formula.

Xn-1

Xn-1 refers to the measuring result from the previous measurement. It is updated every measuring cycle.

- Press **K=**.
The display shows the old value of K.
- Press **Xn-1**.
The display now shows n-1. (n-1 is shown instead of a value since Xn-1 is continuously changing.)
- Press +/- if you want to subtract Xn-1 from the measurement result.
- Confirm by pressing **ENTER**.
- Set constants L and M to the desired values, and select a MATH function.

When the measurement starts, the results will be calculated as usual. The K constant will be set to the previous measuring result before a new measurement starts.



The first measurement after turning on this function is not reliable, since Xn-1 may not hold the expected value. The value of Xn-1 is the measuring result BEFORE the mathematical conversion.

X0

X0 means the measuring result currently displayed. Use HOLD to capture the desired measuring result.

- Setup the measurement you want to make.
- Press **HOLD**.
- Press **RESTART** to obtain the value you want to use as a constant. The result is frozen after one measurement due to HOLD.
- Press **K=**
The display shows the old value of K.
- Press **X0**.
The display shows the measurement result that will be used as a mathematical constant.
- Press +/- if you want to subtract X0 from the measurement result.
- Confirm by pressing **ENTER**.

The instrument will now store and use the measurement result that was displayed after you pressed the HOLD key.

- Set constants L and M to desired values and select a MATH function.
- Switch off **HOLD**.

When the measurement starts, the results will be calculated as usual.

Statistics

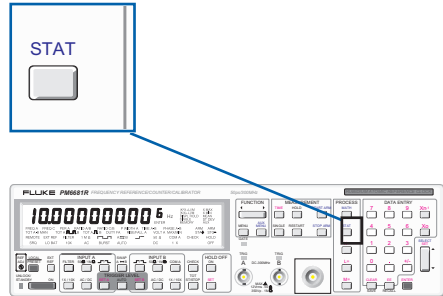

Statistics may be applied to all measuring functions, with the exception of Manual Totalize and AC/DC Voltage. Statistics may also be applied to the result from Mathematics.

The available statistics functions are as follows:

X MAX: Displays the maximum value within a sampled population of x_i -values

X MIN: Displays the minimum value within a sampled population of x_i -values

MEAN: Displays arithmetic mean value (\bar{x}) of a sampled population of x_i -values and is calculated as:

$$\bar{x} = \frac{1}{n} \sum_{i=1}^n X_i$$

ST DEV: Displays standard deviation (s_x) of a sampled population of x_i -values and is calculated as:

$$s = \sqrt{\frac{1}{n-1} \left(\sum x_i^2 - \frac{1}{n} \left(\sum x_i \right)^2 \right)}$$

Where:

x_i = the result of an individual measurement.

Summation is for $i = 1$ to n .

n = the number of measured x_i -values (up to 65 535)

this expression is equivalent to the more common:

$$s = \frac{\sqrt{\sum (x_i - \bar{x})^2}}{n - 1}$$

■ To set statistics

- Press the **STAT**-key.
- Press **SELECT/SET** and select X MAX, X MIN, MEAN, or ST DEV.
- Press **ENTER**.

■ To set n in the PM6681

- Press **STAT**. Current value is displayed.
- Use any numeric key to change value of n.
- Press **ENTER**.

■ To set n in the PM6680B

- Press **AUX MENU**.
- Press **SELECT/SET** and select STAT.
- Press **ENTER**.
- Input sample size n via the keyboard.
- Press **ENTER**.

■ To view X MAX, X MIN, MEAN, and STD DEV

It is possible to stop the measurements and to view X MAX, X MIN, MEAN, and ST DEV from one data capture.

PM6680B

- Press **HOLD**.
- Press **STAT**.
- Press **SELECT/SET** to select statistical function.

- Press **ENTER** to view the result.

If no statistics data has been captured, the display reads “no data”. Press **RESTART** to capture new data.

PM6681

- Press **HOLD**.
- Press **STAT**.
- Press **SELECT/SET** to view the other Statistical function.

If no statistics data has been captured, the display reads ‘Stat XXX’ where XXX is the sample size. Press **RESTART** to capture new data.

Measuring Speed

When using statistics, you must take care that the measurements do not take too long time to perform. Statistics based on 1000 samples does not give a measurement result until all 1000 measurements have been made. That can take quite some time if the setting of the counter is not optimal.

- Do not use AUTO trigger. It is convenient to use but it takes a fraction of a second each time the timer/counter determines new trigger levels, and 1000 or 10000 times a fraction of a second is a long time.
- Do not use a longer measuring time than necessary for the required resolution.
- Remember, if you use SINGLE, that the counter uses the set measuring time as idle time between samples. A short measuring time means a quick statistical result.
- Remember that a frequency measurement normally uses the 225 MHz / prescaled by two mode. If the frequency of your signal is less than 160 MHz, you can almost double the sampling rate by measuring on the

B input (for instance by still using the A input, but with SWAP and COM A on).

Determining Long or Short Time Instability

When making statistical measurements, you must select measuring time in accordance with what you want to obtain:

Jitter or very short time (cycle to cycle) variations require that the samples are taken as Single measurements. This means that time interval averaging is not used.

If average is used (SINGLE turned off) the samples used for the statistical calculations are already averaged. This can be a great advantage when you measure medium or long time instabilities. Here averaging works as a smoothing function eliminating the effect of jitter.

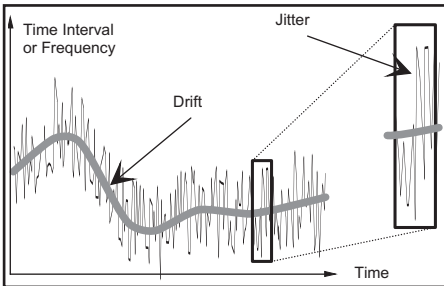

The above signal contains a slower variation as well as jitter. When measuring jitter you must use a limited number of samples so that the slow variation does not become noticeable. Single measurements should be made with the shortest possible measuring time (800 ns),

To measure the slower variation you calculate Max, Min or Mean on a long series of averaged samples. Here averaging eliminates the jitter in each sample and the long measuring time and large number of samples means that

the measurement can record very slow variations. The maximum measuring time for each sample is 400 s and the maximum number of samples is 65535, which in effect means that the measurement can span up to $26.214 \cdot 10^6$ s or about 300 days.

Statistics and Mathematics

The counter allows you to perform mathematical operations on the measured value before it is presented to the display or to the bus. Two equations are available:

$$\frac{(K * X + L)}{M} \text{ and } \frac{(\frac{K}{X} + L)}{M}$$

(default K = M = 1 and L = 0)

Any systematic measuring uncertainty can be measured for a particular measuring setup, and the needed correction constants can be entered into these equations. Statistics will then be applied on the corrected measured value.

Confidence Limits

For example, the standard deviation can be used to calculate the confidence limits of a measurement.

Confidence limits = $\pm ks_x$

Where:

$k = 1$ for a confidence level of 68.3%
(1 σ - limits)

$k = 2$ for a confidence level of 95.5%
(2 σ - limits)

$k = 3$ for a confidence level of 99.7%
(3 σ - limits)

■ Example

A measurement of a time interval of 100 μs is used to illustrate how the confidence limits are calculated from the measurement result.

Use the statistics to determine the mean value and standard deviation of the time interval. Take sufficient samples to get a stable reading. Assume further that the start and stop trigger transitions are fast and do not contribute to the measurement uncertainties. The counter displays:

MEAN value = 100.020 μs and a STD DEV = 50 ns then the 95.5% confidence limits = $\pm 2s_x$ = ± 100 ns.

Jitter Measurements

Statistics provides an easy method of determining the short term timing instability, (jitter) of pulse parameters. The jitter is usually specified with its rms value, which is equal to the standard deviation based on single measurements. The counter can then directly measure and display the rms jitter if:

MEAS TIME is set to SINGLE or N = 1

Otherwise, the standard deviation of mean values may be measured. The rms value is a good

measure to quantify the jitter, but it gives no information about the distribution of the measurement values. To improve a design, it might be necessary to analyze the distribution. Such measurements as well as others can be performed by data capture with a controller and the **TimeView** Frequency and Time Analyzing Software Package that comes as standard with the PM6681.

This page is intentionally left blank

Chapter 7

Auxiliary Functions

About this chapter

This chapter describes less commonly used functions that are “hidden” in the auxiliary menu.

Auxiliary Menu

Introduction

All measuring logic and input settings are computer controlled. The ability to select, combine, and add new functions is limited only by the number of controls on the front panel.

To keep the normal operation of the counter as simple as possible, the use of dual or triple function keys has been avoided. For the same reason the number of keys has been restricted; however, the counters contain many “hidden”

features. The **AUX MENU** key gives you access to all the extras that are not generally found in a traditional counter.

If you frequently need to use some AUX MENU functions, we recommend that you save your favorite complete front panel setup in one of the 19 memory locations for easy recall later.

You can use such preprogrammed settings as default settings for your particular applications, from which you can manually modify the various individual control settings.

When you select something in the AUX MENU that cannot otherwise be indicated, an AUX annunciator on the display is switched on.



The AUX annunciator shows only that a change has been made in the AUX MENU. The unique settings that have been made are not shown on the display.

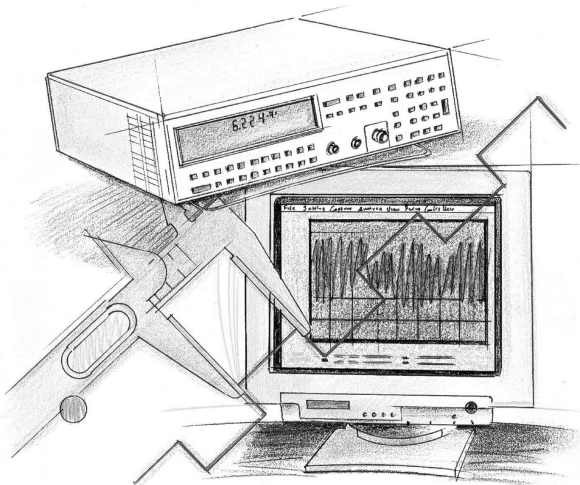

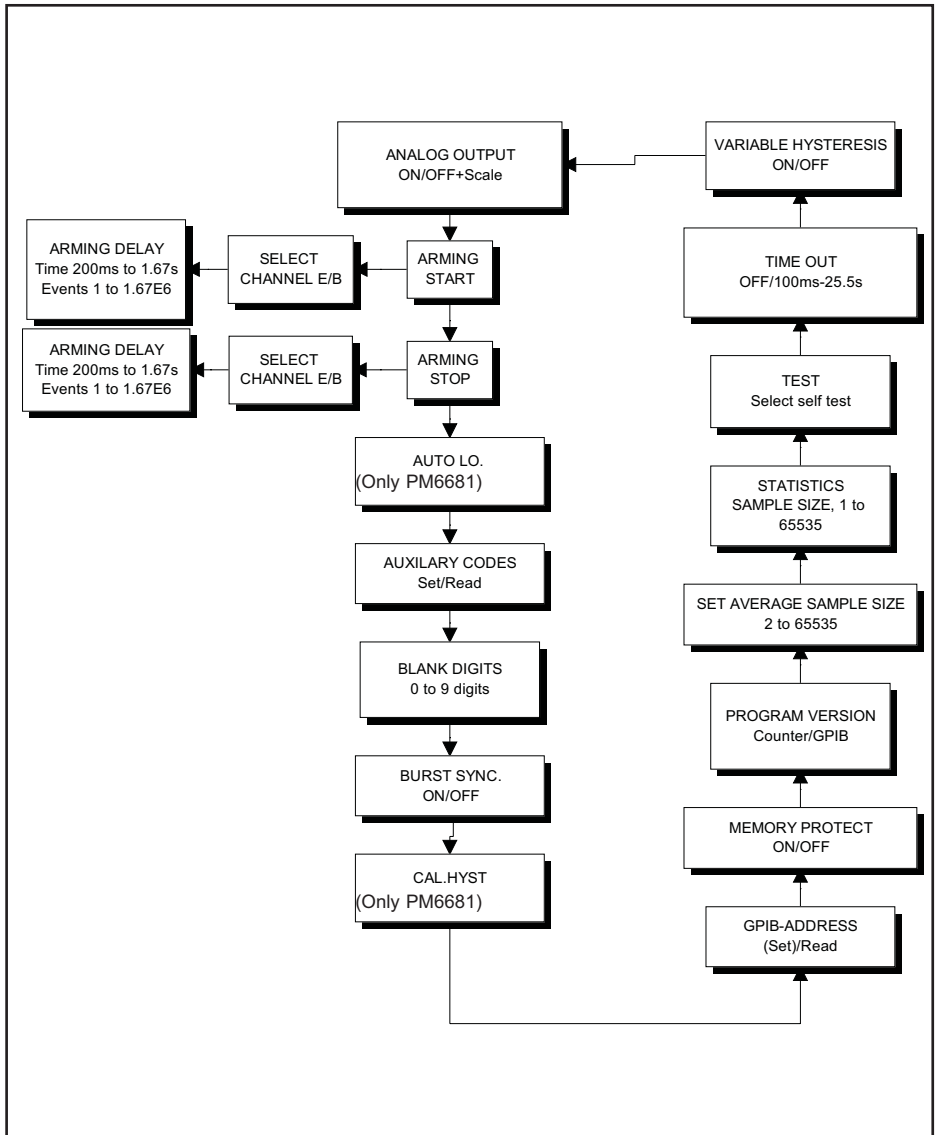

Figure 7-1 You will enter the AUX MENU at the same selection as you used the previous time.

Plain English AUX MENU Commands

AUX MENU



Press **AUX MENU** key for a list of functions. Use the **SELECT** key to scroll through the list. Press **ENTER** to select the function or take you to a submenu with more selections.

SELECT SET



The texts on the display are messages in abbreviated English. Here is a list of all display messages with explanations.

ENTER



Addr

Address: GPIB Address Read/Set

ANALOG Out

Analog output ON/OFF and scaling factor

Ar. Start

Arming Start

Ar. Stop

Arming Stop

AU. CODES

Auxiliary code function

AUTO Lo.

Auto low sets the lower frequency limit for autotrigger and voltage measurements (only PM6681).

blAn. dig it

Blank digits (switch off) up to nine digits

burSt

Burst Frequency

bUS 1.23

Bus 1.23 Identity of the GPIB firmware

Cal. Hyst

Cal. Hyst Used for calibrating the hysteresis of the input amplifiers in the PM6681. Read about how to use this command in the preventive maintenance chapter on page 10-3.

Chan. E

Chan. E Channel (Input) selection for arming (Channel E)

DELAY Cnt

Delay Count Delay arming by event counting

DELAY t.

Delay Time Delay arming by time

Err. Protect

Error Protect You tried to save a front panel setting while the memory was protected

InStr. 1.23

Instrument 1.23 Identity of the Instrument firmware

NEG

Negative

OFF

Off

On

On

POS

Positive

Prog. Idn.

Program Identity

Prot.

Protect Memory Protect Menu

StAt.

Statistics Sets the sample size for statistics

tEST

Test Enter the test submenu

TEST ALL

Test all All tests in sequence

TEST ASIC

Test ASIC (Application Specific Integrated Circuit) Test of measurement logic

TEST dISP

Test Display Display test

TEST rR.

Test RAM Internal RAM test

TEST rO.

Test ROM Internal ROM test

t i. AVG. count

Time Average Count Selects a specific number of events for averaging, instead of a the No. of events during the set measuring time.

t i. Out

TimeOut Timeout menu

tr i9 SLOPE

Trigger slope

UAA. HYSL. A

Variable Hysteresis A To select variable hysteresis for the A-input, (to measure on noisy signals)

■ **Variable Hysteresis A**

Variable hysteresis means that the sensitivity of the A input can be set. This function uses the trigger level A setting as the upper level of the hysteresis band, and the trigger level B setting as the lower level. On the PM6680B this function can only be used for Frequency A. On the PM6681 it can be used on all single channel measurements on channel A.

- Press **AUX MENU**, then press **SELECT/SET** until the display shows **UAA. HYSL. A**

- Select **On** and the counter will select variable hysteresis on input A, activate COM A, and turn on AC and AUTO (which sets the trigger level on A to 75% and on B to 25% of V_{pp}).

You can manually switch off auto triggering and set manual trigger levels after selecting Variable Hysteresis mode.

SET A sets the upper limit of the hysteresis band, and **SET B** sets the lower limit.

- Selecting another **FUNCTION** will switch off Variable Hysteresis A.

Burst Frequency

Burst Frequency turns the burst frequency function on or off and selects measuring input. Read the explanation of this function in Chapter 6 “Measuring Functions”.

BURST is shown to the left of AUTO on the display. The AUX annunciator will not turn on when burst is selected.

- Press **FUNCTION** to turn off burst.

Address, GPIB

On the PM6680B the address set on the rear panel switches is shown. You can only read the set address via the AUX MENU.



On the PM6681 you can also change the address here. The new address is stored in nonvolatile memory and remains until changed again via this menu or via a bus command.



The last set address is the valid address whether it is set via the aux menu or the GPIB command.

The counter also shows the address used during the power-up test.

Protect Memory

Protects memory 10-19 from accidental overwrite, just like the write-protect tab on a diskette.

- Enter the **AUX MENU** and select **PrOt**.
- Press **ENTER** and the display will show **OFF** or **On**.
- To change status, press **SELECT** until wanted status is displayed. Confirm your selection by pressing **ENTER**, and the instrument exits AUX MENU and returns to measuring.

If you attempt to save a front panel setting in these memories when protected, the display will show **Err. ProtEc**.

Time Interval average Sample Size

Here you select if averaging in Time Interval measurements is determined by sample size or measuring time. Average time interval is used in Time-, Rise/Fall-, Phase, Duty factor, and Pulse Width measurements. Use **SINGLE**-key to disable averaging.

- Press **AUX MENU**, then **SELECT/SET** until the display shows **t I. Avg. Count**.
- Press **ENTER** to enter the sub-menu.
- Use the **SELECT/SET**-key to select ON, and confirm by pressing **ENTER**.
- Enter the value via the keyboard. The range is 1 to 65535. Preset value is 100.
- Confirm your selection by pressing **ENTER**.

Example: If the Sample Size is set to 100, the result is averaged from 100 con-

secutive measurements. After the 100 measurements, the counter shows the result for the set measuring time, then a new measurement block is started.

See also; “Average” in Chapter 6.

Timeout

Timeout is a programmable stop for a measurement in progress. The timeout starts when the counter starts a measurement, and it interrupts the measurement if a result is not ready within the timeout period.

- Press **AUX MENU**, then **SELECT/SET** until the display shows **t I. Out**.
- Press **ENTER** to enter the sub-menu.
- Use the **SELECT/SET**-key to select On, and confirm by pressing **ENTER**.
- Enter the sample size via the keyboard. The range is 100ms to 25.5s. Preset value is 100ms.
- Confirm your selection by pressing **ENTER**.

 *The timeout is mainly used for GPIB applications.*

Program Identity

Shows the firmware version of the instrument and the GPIB interface.

- Press **AUX MENU**, then **SELECT/SET** until the display shows **Prog. Idn.**
- Press **ENTER** to see the instrument firmware version for e.g.: **Inst. 1.23**.
- Press **ENTER** again to see the GPIB firmware version e.g.: **bus. 1.23**.
- Press **ENTER** to return to measuring.

Statistics Sample Size

Here you can set the number of samples for use with a statistical process.

This is the only way to change sample size in the PM6680B. In the PM6681 sample size is changed in the normal STAT menu, but it can also be changed in the AUX menu — STAT for compatibility reasons.

- Press **AUX MENU**, then **SELECT/SET** until the display shows **StRt**.
- Press **ENTER** to enter the sub-menu.
- Enter the sample size via the keyboard. The range is 1 to 65535. Preset value is 100.
- Confirm your selection by pressing **ENTER**.

To turn on statistics, you must also select statistical function with the **STAT**-key.

See also Chapter 6, “Processing”.

Test

In the Test menu, you can choose to run tests used in the power-up test one at a time:

- Press **AUX MENU**, then **SELECT/SET** until the display shows **tEt**.
- Press **ENTER** to enter the test menu.
- Press **SELECT/SET** to select one of the following tests:
 - TEST ALL (the four tests below in sequence).
 - TEST DISP (Display Test).
 - TEST ASIC (Measuring Logic).
 - TEST rA (RAM).
 - TEST ro (ROM).

If any fault is detected, an error message will appear on the display and the program halts. Possible error messages are as follows:

- Internal ROM test failed.
 - Internal RAM test failed. The hex-address where an error is detected is shown.
 - Test of measuring logic failed.
- If an error message is displayed, press any key to make the instrument continue even though an error was detected. Contact your local Service Center for repair.



The display test turns on all segments of the display for a visual inspection. No failure is reported.

*On the PM6680B the display is switched off after a second. On the PM6681 press **ENTER** to end the test.*

Blank Digits

Blanks out unstable digits on the display.

- Press **AUX MENU**, then **SELECT/SET** until the display shows **blAn. d iG It**.
- Press **ENTER** and use the keyboard to enter the number of digits you want to blank out. Blanked digits are numbered from LSD to MSD, right to left.

Arming Start

Selects if the counter start arming should be delayed by time or by event counting and sets the delay.

■ PM6681

- Press **START ARM**.
- Select arming slope **Ar. StA POS** or **Ar. StA NEG** with the **SELECT/SET** key.
- Select **ChAn. E** or **ChAn. b** as arming input.

- Press **ENTER** and the display will show **dELAY OFF**.
- Press **SELECT/SET** to select **dELAY t**, for time delay, or **Cnt** for delay by events, and press **ENTER**.
- Enter the delay you want from the arrival of the arm start signal to the actual start of a measurement.
- Press **ENTER** to exit the menu.

■ PM6680B

- Press **AUX MENU** and select **Ar. Start**, .
- Press **ENTER**.
- Select **CHARn. E** or **CHARn b** as arming input.
- Press **ENTER** and the display will show **dELAY OFF**.
- Press **SELECT/SET** to select **dELAY t**, for time delay, or **Cnt** for delay by events, and press **ENTER**.
- Enter the delay you want from the arrival of the arm start signal to the actual start of a measurement.
- Press **ENTER** to exit the menu.

To use the selected start arming delay, you must turn on start arming:

- Press the **ARM START** key on the front panel.
- Select arming slope **POS** or **NEG** with the **SELECT/SET** key.
- Press **ENTER** to exit the menu.

Arming Stop

Selects if the counter stop arming should be delayed by time or by event counting and sets the delay.

■ PM6681

- Press **STOP ARM**.
- Select arming slope **Ar. Sto POS** or **Ar. Sto NEG** with the **SELECT/SET** key.
- Select **CHARn. E** or **CHARn b** as arming input.
- Press **ENTER** and the display will show **dELAY OFF**.
- Press **SELECT/SET** to select **dELAY t**, for time delay, or **Cnt** for delay by events, and press **ENTER**.
- Enter the delay you want from the arrival of the arm stop signal, to the actual stop of a measurement.
- Press **ENTER** to exit the menu.

■ PM6680B

- Press **AUX MENU** and select **Ar. Stop**,
- Press **ENTER**.
- Select **CHARn. E** or **CHARn b** as arming input.
- Press **ENTER** and the display will show **dELAY OFF**.
- Press **SELECT/SET** to select **dELAY t**, for time delay, or **Cnt** for delay by events, and press **ENTER**.
- Enter the delay you want from the arrival of the arm stop signal, to the actual stop of a measurement.
- Press **ENTER** to exit the menu.

To use the selected stop arming delay, you must switch on stop arming:

- Press the **STOP ARM** key on the front panel.
- Select arming slope **POS** or **NEG** with the **SELECT/SET** key.
- Press **ENTER** to exit the menu.

Analog Output

The analog output is turned off as a default.

Press **AUX MENU**, then **SELECT/SET** until the display shows **ANAL OG Out**.

- Press **ENTER** to enter the sub-menu.
- Use the **SELECT/SET**-key to select On, and confirm by pressing **ENTER**.
- Enter the scaling factor via the keyboard. Preset value is 1.
- Confirm your selection by pressing **ENTER**.

■ Scaling factor

The scaling factor has two functions:

- Its exponent selects which digits to output on the analog output
- Its value sets what reading should represent full scale

As default, the scaling factor is 1 (1E0). This means that the full scale value is 0.999, and the analog output converts the fraction (digits to the right of the decimal point) to a voltage.

The scaling factor should be:

$$\text{Scaling factor} = \frac{1}{\text{full scale value}}$$

where full scale value is the value for which you want the analog output to output its maximum voltage (5 V).

Example:

- We want to follow the 0 to 1 kHz- variation that is 0.000 kHz → 0V output and 0.999 kHz → 5V output.
- Take a measurement result, for instance: 12.34567890 E+6 Hz
- Represent this result without exponent: 12345678.90 Hz

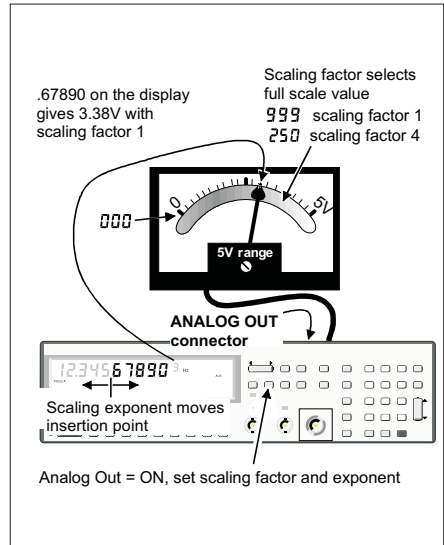

Figure 7-2 The analog output function.

- To get the “kHz-value”, multiply this value with the scaling factor, for instance 0.001. 12345.67890
- Take the fractional part of the result: .67890
- This is the value that will determine the output voltage, .00 will give 0 V and .99 will give 5 V. This means that “our” reading will give .67890*5=3.3945 V. This is output as 3.38 V due to the 0.02 V resolution of the analog output.

■ Resolution

The analog output range is 0 to 5 V in 250 steps, so one step is 0.02 V. If the scaling factor is 1, one such step is taken each time the display changes with X.004, and if the scaling factor is 4, one step is taken each time the display changes with X.001.

The X in the above paragraph can be any digit and does not influence the output voltage. If the display changes from 0.996 to 1.000, the voltage drops from 4.98 V to 0V. If the display value increases further, the output voltage starts to increase again; see Figure 7-4.

AUTO LOW

ONLY PM6681



Here you can set the minimum frequency for which you want AUTO trigger and Volt max/min measurements to work. A high frequency limit means that AUTO determines trigger levels faster and that Volt max/min display can follow quick variations.

- Press **AUX MENU**, then **SELECT/SET** until the display shows **AUTO Lo.**
- Press **ENTER** to enter the sub-menu.
- Enter the lowest frequency you want for AUTO and Volt via the keyboard. The range is 1Hz to 50 kHz. Preset value is 100 Hz.
- Confirm your selection by pressing **ENTER**.

■ Example

An example of use is if you have an LF AC voltage, with a repetition rate of less than 1Hz for which you want to get the absolute maximum or minimum V_{pp} by using statistics. A slow voltage function would average the signal and get a too low V_{pp} while a high frequency limit (much higher than the actual frequency) would asynchronously sample the signal and give the absolute max/min peaks. Note that when statistics is off, the display will show garbage.

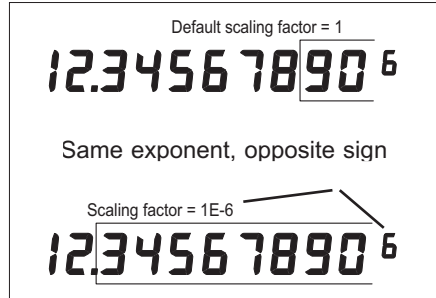

Figure 7-3 To use the shown decimal point as reference; set the exponent of the scaling factor to the same value as the display exponent, but change sign.

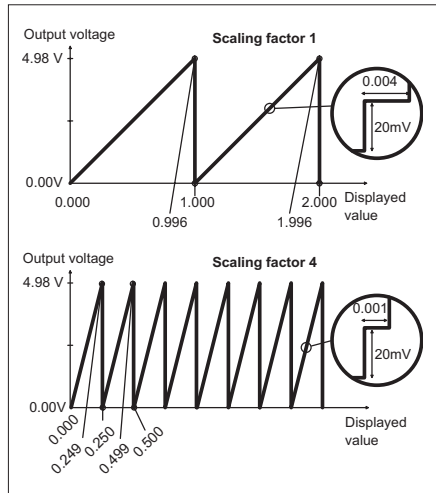

Figure 7-4 Output voltage versus displayed value for two different scaling factors.

Auxiliary Codes

Code setting

By pressing **ENTER** when the display shows **Fun. Codes**, you get the current setting of the counter expressed as an 8-digit code. This auxiliary code is divided into the following sections, separated by points and space:

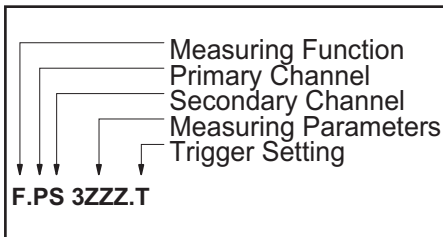

Figure 7-5 The counter setting expressed as an 8-digit code.

When you enter a code, you must enter it in groups **F.PS** or **3ZZZ**. The decimal-point in **F.PS** and the leading **3** in the **3ZZZ** to tell the counter which group you are editing.

F is the *measuring function*, represented by a number from 1 to 21; leading zeros will be truncated. All functions are shown in the table on the next page.

PS shows what input is used as the *Primary* and *Secondary* measuring channel. **P** and **S** are separate numbers between 1 and 7, representing channels as described in the following table.

Channel	P/S	Note
A	1	A Input used
B	2	B Input used
C	3	Optional Prescaler
E	4	Arming Input (at rear)
$\frac{A}{N}$	5	Frequency A divided by N. N=2 for the PM6680B N=4 for the PM6681
Reference	6	Internal or External Ref. oscillator
Hysteresis	7	Variable Hysteresis mode

Table 7-1 Channels

Chapter 7, “Measuring Functions” further describes the $\frac{A}{N}$, Reference, and Variable Hysteresis.

Function		Channel		
F		Primary P	Secondary S	Select from:
Fre- quency	1	Freq	Not used	1 to 7
Period	2	Per	Not used	1 to 7
Ratio (P/S)	3	Nume- rator	Denomi- nator	1 to 5
Pulse Width, Pos	4	Gate	Not used	1, 2, 4
Pulse Width, Neg	5	Gate	Not used	1, 2, 4
Time In- terval	6	Start	Stop	1, 2, 4
Phase	7	Refe- rence Signal	Delayed Signal	1, 2
Totalize Manual)	8	Total	Subtractor	1, 2, 4
Totalize Start/ Stop	9	Total	Start/Stop	1, 2, 4
Totalize Gated	10	Total	Gate	1, 2, 4
Duty Factor	11	Duty Factor	Not used	1, 2, 4
Negative Duty Factor	12	Duty Factor	Not used	1, 2, 4
Rise Time	13	Start/ Stop	Not used	1
Fall Time	14	Start/ Stop	Not used	1
Voltage	15	Max/Min	Not used	1,2
Burst Fre- quency	16	Freq	Not used	1 to 7

Function		Channel		
F		Primary P	Secondary S	Select from:
Pulse Repeti- tion Fre- quency	17	PRF	Not used	1 to 7
Volt	18	Max	Not used	1, 2
Volt	19	Min	Not used	1, 2
Totalize Gated Accumu- lated	20	Total	Gate	1, 2, 4
Totalize Timed *)	21	Total	See Note	1, 2, 4

Table 7-2 Measuring Functions.

*) Set S to the same as P if you want the registers to be connected in series (long register).

Example: 8.11 means Long Register TOT A Manual. (Described on page 4-18).

Totalize Gated Accumulated (F=20) always uses long register.

3ZZZ is a *measuring parameter* for different settings that are turned on or off. This parameter is the sum of a 9-bit register added to 3000.

Setting	Decimal Value	Purpose
Clear	0	Default
Interpolator auto-calibration Off	1	No auto-calibration of interpolators between measurements. Gives a short-term guaranteed resolution of $\frac{250ps}{\sqrt{N}}$, not limited to 100 ps in the PM6680B. Long-term drift gives now poorer systematic error.
Interpolators switched off	2	Interpolating technique is not used. Only of interest for IEEE-bus use.
Gated voltage mode	4	Set enable on external control, input B or E. When external control is active, the voltage measurement is enabled. Can define a time window to (disable) measure Volt, for instance during pulse overshoot. Stop arming cannot be used in Gated volt mode.
High-speed voltage mode	8	Fast signal detection to speed up voltage measurements in the PM6680B. Intended for signals of higher frequency than 10 kHz or DC level.

Setting	Decimal Value	Purpose
Count mode for average measurements	16	In time interval modes (not single), measurements are averaged, during a preset number of intervals instead of during the preset measuring time. This function is normally controlled by TI.AVG.COUNT.
Slope on E-channel	32	Negative trigger slope when input E is used as a measuring channel.
Not used	64	
Analog Out On	128	Turns on Analog Out, at the cost of IEEE-bus speed, which functions simultaneously. This function is normally controlled by ANALOG OUT.
Event Counting mode	256	Arming delay or Hold Off delay by trigger events counted, instead of set delay time.

Table 7-3 Measuring Parameters (3ZZZ)

.T is a number between 0 and 3 that describes AUTO triggering mode for channels A and B. Here you can see if auto-trigger is turned on for only one of the A or B inputs (Split-Auto). You can only read the trigger conditions, not set them.

.T	Auto trig A	Auto trig B
.0	off	off
.1	off	on
.2	on	off
.3	on	on

Table 7-4 Trigger Settings

■ Examples

Determining an AUX CODE

You want to perform a Time Interval measurement from channel A to E, in 'average by count' mode with the default sample size of 100 measurements, and without interpolator calibration after each measurement.

Start by selecting Function, Primary and secondary channel. Look at Tables 7-1 and 7-2 to find the following information:

Time Interval	6
Input A	1
Input E	4

Put the values together as parameters for F.PS:

6.14

Now switch off auto calibration, set average to count mode, and switch on the Analog Out on. Refer to Table 7-3 to get the following information:

Interpolator auto-calibration off	1
Count mode for average measurements	16
	<hr/>
	= 17
Offset	+ 3000
	<hr/>
3ZZZ	= 3017

Add the values from the settings and you get the sum 17. Then add 3000, which is an offset to the memory location, and you get following parameter for 3zzz:

3017

To Interpret an AUX CODE

You read a parameter on the display and want to interpret it. We will use the following as an example:

2.11 3011.0

2.11 is the F.PS, the first digit(s), in front of the first point, are the measuring function and 2 means Period measurement. The digits after the point are measuring channels and 11 means input A, only the first 1 is of importance here since Period is a single channel measurement.

3011. is the 3ZZZ, which is a sum that you must split in the following way:

	3011
Subtract the offset	$\begin{array}{r} 3011 \\ - 3000 \\ \hline \end{array}$
Result	11
Subtract the highest possible number from table 7-3 (8=High Speed voltage mode)	$\begin{array}{r} 11 \\ - 8 \\ \hline \end{array}$
Result	3
Subtract the highest possible number from table 7-3 (2=Interpolators switched off)	$\begin{array}{r} 3 \\ - 2 \\ \hline \end{array}$
Result	1
Subtract the highest possible number from table 7-3 (1=Interpolator auto-calibration switched off)	$\begin{array}{r} 1 \\ - 1 \\ \hline \end{array}$
Result	0

The digit after the point in 3011.0 indicates trigger mode according to Table 7-4, and zero means that triggering is set manually on both A and B channels.

This page is intentionally left blank.

Chapter 8

TimeView for PM6681

Introduction

TimeView turns the PM6681/PM6681R into a powerful tool for time and frequency analysis.

Applications

The major applications for TimeView are as follows:

- Analysis of frequencies that should be stable
- Analysis of frequencies that are modulated
- Analysis of frequency transitions/sweeps

Features

Features of TimeView include:

- Fast, simple acquisition of results
- Automatic display of results in graphic format
- Cursor measurements; plus histograms and FFT for analysis
- Easy generation of reports via graphics hard copy using HP LaserJet or IBM ProPrinter
- Storage of acquired data and measurement setups

The TimeView documentation

The documentation for TimeView is integrated into this Operators Manual.

In addition to the actual program, the TimeView diskette contains a help file, example files and a README.TXT file with the latest information about the program.

Installation

Software Installation

You may run TimeView either directly from the TimeView disk or install it on your hard disk and run it from there.

Make a Backup Copy

Before running TimeView for the first time, make a backup copy of your TimeView diskette and store the original in a safe place.

Installation On Your Hard Disk

■ Using the Install Program

Insert the TimeView disk in your disk drive and type

```
A: ◀  
INSTALL ◀
```

from the command prompt. Follow the instructions on the screen. (Substitute appropriate drive letter for A.)

■ Starting TimeView From the Hard Disk

Type
CD \TimeView ◀
TVPM6681 ◀
from the hard disk command prompt.

Starting TimeView From the Floppy Disk

No installation is necessary to run the program; the only thing to remember is that the disk must not be write protected.

Insert the TimeView disk in your disk drive and type

```
A: ◀  
TimeView ◀  
from the command prompt and TimeView will run. (Substitute appropriate drive letter for A.).
```

Manual Installation

Make a directory on your hard disk called, for instance, C:\TimeView\PM6681. Copy the program and example files to this directory.

Type
C: ◀
CD \ ◀

TimeView for PM6681

```
MD TimeView↓
CD TimeView↓
MD PM6681↓
```

- at the command prompt.
- Insert the disk in the disk drive.
- Type

```
COPY A:*. *
C:\TimeView\PM6681↓
```

at the command prompt, and TimeView will be installed.

TimeView.CFG where it stores information about which interface card you use and the default parameters you have chosen. It stores this file in the directory from where you start TimeView. You can force this file to a specific directory to avoid several configuration files on your hard disk.

- Use your favorite Text Editor to open the AUTOEXEC.BAT file.
- `SET TimeView_81=path`
where path is the path to the directory where you want to store the .CFG file, e.g., C:\TimeView\PM6681
- Save AUTOEXEC.BAT as an ASCII file.
- Copy TimeView.HLP and TimeView.SET to this directory
- Restart your computer and start TimeView.

Startup Options

TimeView automatically detects if it is connected to an EGA or VGA screen. Startup option /EGA forces TimeView to run in the 350-line EGA mode.

You may load files when starting TimeView by appending the file names to the start command, separated by space.

Temporary Files

TimeView sometimes needs to create temporary files. One such case is when you go to DOS from the File menu.

These files are named TV_SWP*. where * is a number between 1 and 99. These files are created in the TMP directory specified by the `SET TMP=path` command.

If no TMP directory exists, TimeView uses the directory selected by the `SET TimeView_81=path` command.

If none of these directories exists, TimeView stores its temporary files in the current directory.

Should you exit TimeView incorrectly, for instance by pressing Alt+Ctrl+Del, temporary files will remain on your disk. When the number of files reaches 99, TimeView will stop swapping to disk, and will not work properly.

So, make it a rule to once in a while search your disk for TV_SWP*. files and delete them.

Hardware Installation

To be able to capture data you must have a GPIB interface card in your PC and an IEEE488 cable to connect the counter to the PC. To install the interface in your PC, follow the instructions accompanying your Philips, National, or Capital equipment (CEC) interface card.

TimeView Messages After Installing an Interface Board

■ Can't find National/Philips interface card

The software driver GPIB.COM must be in your CONFIG.SYS file; otherwise, TimeView will not find the card. If it still cannot find the board, there might be an interrupt conflict. This board normally uses interrupt IRQ 7. The owner of this interrupt is normally the printer port LPT1. Since LPT1 owns IRQ 7 but doesn't use it, the GPIB interface can take it over. However, if another hardware has already taken over IRQ 7 from the printer port, you must use another interrupt. How to change interrupt is described in the installation manual of the board but also in the program IBCONF that accompanies some later versions of the interface. Run this program and you will get a graphic presentation of how to move jumpers and set DIP-switches.

NOTE! Both a jumper and some switches must be set to change the interrupt. Insert the board and try again.

■ Can't find Capital Equipment GPIB firmware. Is there a card installed? Y/N

If you have installed a CEC interface and get this message, the CEC ROM has probably been masked by other software. This can happen on 386 PC's using DOS 5.0 or a memory manager to load programs in "High" memory, between 640k and 1024k. TimeView can cope with this conflict if you just tell TimeView that a CEC card is installed and what IO address to use:

- Answer YES to the question "Is there a card installed? Y/N".
- Answer with the IO port address when you get the "Enter CEC card IO address (HEX): 2b8" prompt. The address 2b8 is the default IO address used by CEC. If this address does not work, check the switch settings on your card and enter the correct address.

CAUTION: When you press Enter in this pop-up window, TimeView writes to that address and to whatever hardware is using that address. An incorrect address may cause trouble, so don't just guess the address if you know it has been changed from the default value.

Since other programs, like Basic, use the ROM program on the CEC board and must access the CEC board address range, we recommend a proper installation of the board:

The CEC board normally occupies the address range cc00-cdff. The PC must not have any other hardware using these addresses. If it has, remap the CEC board or the other hardware to address ranges that don't overlap.

Another problem may be that you run an Expanded Memory manager that uses all "free" memory addresses to increase the RAM mem-

ory available. Examples of such software are EMM386 from DOS 5 and Windows, 386MAX and QEMM. Here you must inform these programs that the CEC board exists and what addresses it occupies. The way to do this is described in the manuals for the programs. As an example we show the EMM386 as it is common for all users running DOS 5 or Windows.

If EMM386 is installed on your PC, you will find a line like the one below in your CONFIG.SYS file.

```
DEVICE=  
C:\DOS\EMM386.EXE m9 RAM
```

Add the following to that line:

```
x=cc00-cdff
```

If you have selected another address range for your CEC board, you should use that range here too.

Restart your PC and start TimeView again.

■ Can't find counter, power on and try again?

Check if the counter is on and connected to the interface card, if it is you may have the same problem as described in the two preceding error messages.

Configuring TimeView

The Config Menu

Here you can select GPIB interface, interface time-out, printer destination, printer type, printing of setting data on graphs, and screen type.

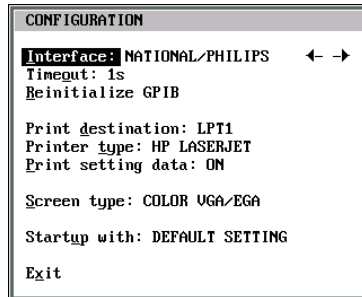

■ Interface

The interface can be selected to either NATIONAL/PHILIPS, CEC, or NONE. If you select National/Philips or CEC, TimeView searches for an interface and then for the timer/counter. When TimeView finds it, the selections made in the Settings menu are performed. Select NONE if you don't have an interface or a counter. You can then use TimeView for working with saved files.

■ Time-out

Set GPIB controller time-out to: 1s, 10s, OFF

If the counter does not respond over the GPIB bus within the set time-out, the GPIB interface will be reset to prevent a "hang-up". Time-out will occur, for example, when the input signal to the counter is missing or occurs too late. It is recommended to ALWAYS set a time-out. OFF should only be set when the measuring

time or the input signal period is longer than 10 s.

■ Reinitialize the GPIB

Reinitializing the GPIB makes TimeView set up the GPIB interface and the counter according to the selections made in the Settings menu. This is useful if you want to use the timer/counter manually and afterwards restore it to the settings TimeView expects the counter to have.

■ Printer

The printer destination can be set to LPT1, LPT2, or LPT3, and the printer type can be an IBM Proprinter or HP Laserjet. If you have another printer, select HP LaserJet for all laser printers and IBM Proprinter for all dot matrix printers. As a rule, most laser printers have an HP LaserJet emulation mode, and most dot matrix printers have an IBM ProPrinter emulation mode.

If you switch on “print setting data” in the configuration menu, TimeView prints the time, date, and settings on the graph hard copies.

■ Startup

Here you select whether TimeView should continue with the settings you had the last time you used it or return to default settings every time you turn it on.

■ Screen

Select COLOR if you have a color monitor and MONO if you have a monochrome monitor or prefer a monochrome picture on your color monitor. The User Interface

Software installation (Windows NT)

This part describes the installation of TimeView for Windows NT users. Installation instructions for DOS (incl. DOS-windows in Windows 3.X and Windows 95) are found on pages 8-3 to 8-7.

Make a backup copy

Before installing TimeView, make a backup copy of your TimeView diskette and store the original in a safe place.

Installation by INSTALL-program

Insert the Timeview disk in your disk drive and type

A: ↵

INSTALL↵

from the command prompt or start A:\INSTALL.BAT from the File Manager (Explorer). Follow the instructions on the screen.

■ TIMEVIEW.CFG

TimeView creates a configuration file called TIMEVIEW.CFG which contains information about the interface card and the default parameters you have chosen. This file is normally stored in the current directory when you start TimeView.

Via the environmental variable TIMEVIEW_81, Windows NT can locate this file to a specific directory. The TIMEVIEW.HLP file must also be in this directory for the help function to work. *This environmental variable must be manually set in Windows NT. See below.*

Manual installation

■ Copy program files and example files archive

Make a directory called e.g. C:\TIMEVIEW on your hard disk. Copy the program and example files to this directory.

- Open a DOS-window and at the command prompt, type:

```
C: ↵  
MD C:\TIMEVIEW↵  
MD C:\TIMEVIEW\PM6681↵  
CD C:\TIMEVIEW\PM6681↵
```

- Insert the installation disk in the disk drive.

- Type

```
COPY A:*. *  
C:\TIMEVIEW\PM6681↵
```

■ Expand example files

The example files are compressed into a self-extracting archive and need to be expanded before use.

- Type

```
C:\TIMEVIEW\PM6681\81_EX.EXE↵  
to expand the example files. When the expansion is ready you may delete the 81_EX.EXE file to save disk space.
```

■ Set the environmental variable TIMEVIEW

You need to define the directory where TimeView stores its configuration file (TIMEVIEW.CFG) respectively help file (TIMEVIEW.HLP). In Windows NT, this is done via setting the environmental variable TIMEVIEW, in the SYSTEM folder in the CONTROL PANEL.

- Double click the CONTROL PANEL icon followed by the SYSTEM icon

- Select USER DEFINED ENVIRONMENTAL VARIABLES and add the following line:

```
SET TIMEVIEW_81=path
```

where **path** is the path to the directory where you want to store the TIMEVIEW.CFG file, e.g., C:\TIMEVIEW\PM6681

GPIB-card installation in a PC running Windows NT

To be able to capture data you must install a GPIB interface card in your PC, and connect it to the PM6681 via an IEEE-488 cable. *In a Windows NT environment, only GPIB-cards from National Instruments that explicitly are designed for Windows NT can be used.* Examples are AT-GPIB/TNT and PCI-GPIB.

To install the interface in your PC, follow the instructions accompanying your National Instruments GPIB interface card.

■ Special considerations for Windows NT users

In addition to the GPIB-card installation procedures, provided by National Instruments, you must take further steps to enable the TimeView program (a DOS software) to run.

You must load the special GPIB-device driver **GPIB-NT.COM** instead of the **GPIB.COM** which is normally used with DOS. The National Instruments' GPIB-card installation program for Windows NT, copies the **GPIB-NT.COM** file to a new subdirectory called **DOSWIN16**.

■ Make GPIB-NT.COM available for TimeView

To enable TimeView to use **GPIB-NT.COM**, you must modify your **CONFIG.NT** file to

load **GPIB-NT.COM**, whenever TimeView runs. The **CONFIG.NT** is located in the **SYSTEM32** subdirectory to your Windows NT directory, e.g.

C:\WINDOWS\SYSTEM32.

■ Modify CONFIG.NT

To enable Windows NT to load **GPIB-NT.COM**, start your text editor, open **CONFIG.NT** and add the following line to your **CONFIG.NT** file:

```
DE-
VICE=path\DOSWIN16\GPIB-NT.COM
```

where *path* is the directory where the GPIB software is installed by the National Instruments' installation program. The default installation directory is **C:\GPIB-NT.**

Different ways of starting TimeView

After installation, TimeView is started from the File Manager (Explorer) or run from the command prompt,

You can also load and start TimeView, like other programs, from a folder on the Windows desktop, e.g. by creating a TIMEVIEW.PIF-file (consult the Windows NT documentation on how to create PIF-files). In the installation diskette, a Windows icon file (TIMEVIEW.ICO) is included.

■ Starting TimeView from a folder

Point on the TimeView icon with the mouse pointer and double-click.

Starting TimeView from the command prompt

```
Type
CD \TIMEVIEW\PM6681
TIMEVIEW
```

The TimeView Screen

The TimeView screen contains the following elements.

- The Menu Bar lists the names of available pull-down menus.
- When you select an item from the menu bar it displays a Pull-down Menu with a list of commands that you can choose from.
- Pop-Up Windows appear when TimeView needs additional information on a command you have selected from the pull-down menu.
- The Title Bar shows the analysis method used, the measuring function used, and the type of data capture.
Example:
FFT FREQUENCY A Free Run
- The Graph Area shows the captured data or the analysis result and the cursors.
- The Cursor Data Area shows the X and Y position of each measurement cursor and the difference between them (δx and δy).

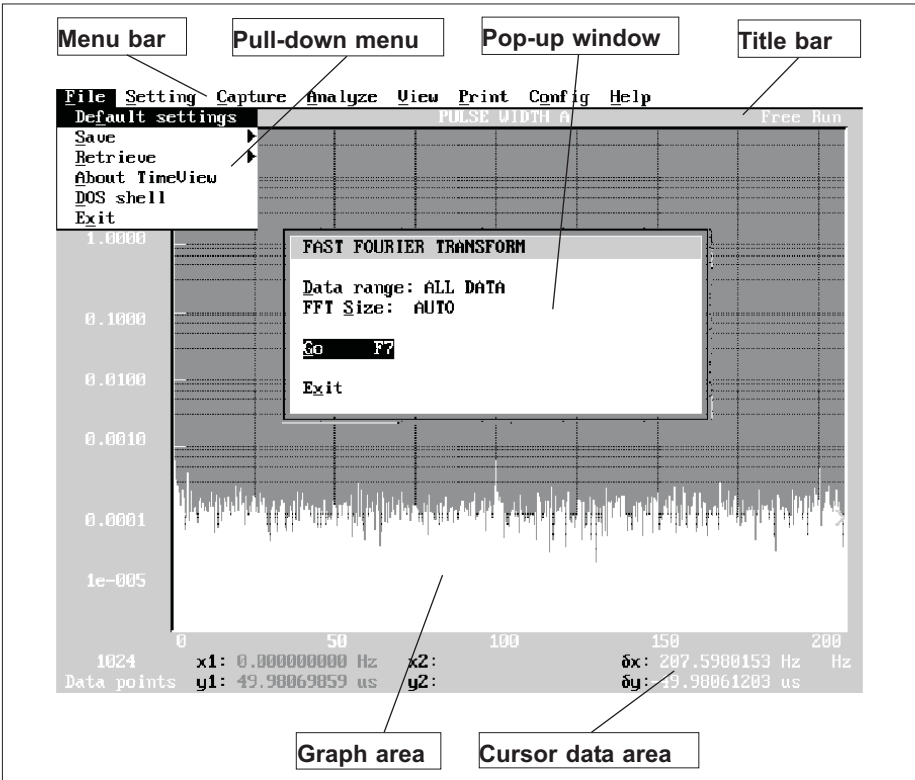

How to use the Elements of the TimeView Screen

■ Menu Bar

Press **ALT** key to activate the menu bar. In the menu bar, you can select menus either by moving the cursor to the menu you want and pressing **ENTER** (or the down arrow key), or by typing the underlined letter. In the pull-down menus you select functions, i.e., using the up/down arrow keys to move the black field, to the command you want and pressing **ENTER**, or by typing the underlined letter. Gray text shows that the field is inactive and can't be selected; for instance, you cannot print a hard copy if no graph is on the screen.

An arrow to the right of a field means that it has a sub-menu. The sub-menu can be entered as above or by pressing the right arrow. Fields that end with “...” have pop-up windows. You exit a menu level by pressing the **ESC** key. Leave the menu bar by pressing the **ALT** key or the **ESC** key.

■ Pop-up Windows

To select commands, use either the up and down arrow keys, **Tab**→ and **Tab**←, or type the underlined letter. Fields in the pop-up windows ending in “...” have sub-menus, while fields ending in “:” are input fields.

To change numerical input fields, use the digits (0 to 9), decimal point (.), + and – or type

maximum or min for upper or lower parameter limit. A or AUTO sets auto (or default) value.

Change the exponent by entering E and the value of the exponent. You may also enter a value into a numerical field as a time in ps, ns, us, or ms. Typing the first letter is enough. Use the left and right arrow keys to change fields containing strings, e.g., Single in the Setting menu. These fields end with two arrow symbols ($\leftarrow\rightarrow$). Fields without trailing dots or colons execute a function. For example, Measurement readout in the Setting menu makes the counter measure continuously, displaying the result on the screen.

■ Graph Cursors

If you press left or right arrow keys when in the graph window, two cursors appear. TimeView shows the coordinates of the cursors and the difference between them below the graph. In the distribution histogram, δy is the number of samples between the cursors. Use the right and left arrow keys to move the left (red) cursor. The cursor moves in bigger steps when you hold down CTRL. HOME moves the cursor to the beginning and END to the end of the graph. If you want to move the right cursor, press the SHIFT key or turn on scroll lock. When you press Ctrl-Z, TimeView zooms in the graph and creates a new graph of the data between the cursors. Ctrl-O zooms out to the original graph.

The cursor movements are summarized in the table below:

Scroll lock has the same effect as holding down the shift key.

Menu Tree

This is a quick reference command summary.

File

- Default settings
- Save
 - Setting
 - Free-running measurement
 - Repetitive sampling data
 - Waveform data
- Retrieve
 - Setting
 - Free-running measurement
 - Repetitive sampling data
 - Waveform data
- About TimeView
- DOS shell
- Exit

Setting

- Counter setting
- Default Counter setting

Capture

- Free-running measurement
- Repetitive sampling data
- Waveform data

Analyze

- Statistics
- Fast-Fourier transform
- Smoothing

View

- Captured data
- Analyzed data
 - Statistics
 - Fast-Fourier transform
 - Smoothing
- Graph info
- Zoom in
- Zoom out
- Scale

Print























- Hard copy

Config

- Config

Help

- Help

			Moves red cursor to the right
			Moves red cursor to the left
	 +		Moves green cursor to the right
	 +		Moves green cursor to the left
	 +		Moves red cursor to the right in big steps
	 +		Moves red cursor to the left in big steps
 +	 +		Moves green cursor to the right in big steps
 +	 +		Moves green cursor to the left in big steps
			Moves red cursor to the left edge of the screen
	 +		Moves green cursor to the left edge of the screen
			Moves red cursor to the right edge of the screen
	 +		Moves green cursor to the right edge of the screen

View

Captured Data

Select View Captured data when you want to return to the F vs. t diagram after analyzing data.

Use CTRL-A to view the graph of the active captured data (the last captured or retrieved data).

Analyzed Data

Selects whether TimeView should display Statistics (distribution histogram), Fast-Fourier transform or Smoothing data.

If you initiate a new data capture while TimeView shows analyzed data, it will make the same analysis on the new data and directly display the analysis result.

Use CTRL-D to view the Distribution histogram, CTRL-F to view the FFT graph and CTRL-T to view the smoothed graph.

Graph Info

Here you can see the file name of a graph and the counter settings used when a graph was created.

■ Comment Your Graphs

You can also enter and edit your own comments in the graph info menu. The comments can be up to 59 characters and will be printed when you print the graph. The comment will also be displayed together with other graph info each time a file is retrieved.

Zoom In

Zooms in on the graph, drawing a new graph of the data between the cursors. If you zoom in on a graph with auto scaling off, TimeView only zooms along the X-axis.

Use CTRL-Z to zoom in.

Zoom Out

Redraws the original graph.

Use CTRL-O to zoom out.

Scale

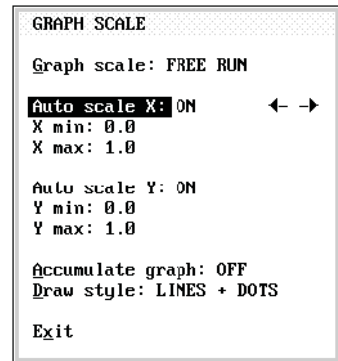

■ Graph Scale

TimeView has one set of scales for each presentation mode. Use the Graph scale to select what graph you want to set scales for: Choices are Free Run, Repetitive sampling, Statistics, FFT or Smoothing.

■ Auto Scale

If Auto Scale is on, TimeView uses the maximum and minimum values in the data as maximum and minimum coordinates for the graph. Autoscale can be switched on/off separately for the X and Y axis.

If auto scaling is off, you can enter your own coordinates. Use this, for example, when comparing two graphs. Or when you want to have the same Y-scale when viewing all data or zoomed-in data between the cursors.

■ Accumulate Graph

This selection controls when the graph should be erased from the screen.

- OFF means that the screen is cleared between each capture.
- DOUBLE means that two graphs are shown together. The old graph is blue and the new graph is yellow.
- MULTIPLE means that the screen will not be erased at all. All old graphs are blue and in the background.

The blue graphs exist only on the screen and on printouts made when they are on screen. When you save the measurement results, only the current yellow graph will be saved.

Double

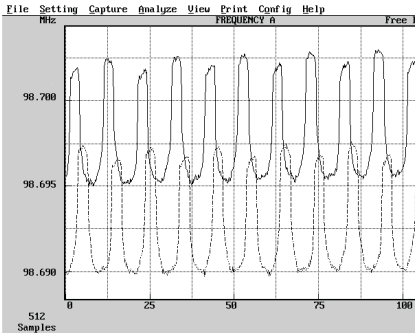

Figure 8-1 Double gives one graph on top of the previous graph.

The purpose of the DOUBLE function is to be able to compare new measurements with ref-

erence measurements made earlier. You can use the previous measurement or recall the graph from a reference measurement made earlier and stored on disk.

The two graphs can be shifted in respect to each other by using the + and – keys. Pressing Shift while shifting the graphs will increase the speed.

Page Up and Page Down swap the foreground and background graph.

Arrow Up and Arrow Down move the cursors between the graphs so that you can measure on both graphs.

DOUBLE cannot be used on analyzed data.

Multiple

Each new graph is put on top of the old graphs. This is useful if you are looking for some irregularity that occurs once in a while. With just one graph, the irregularity could be impossible to see, but with many graphs on top of each other it is easy to see.



If Scale is set to AUTO, the scale of the graph is taken from the first measurement and is not changed even if the measurement value requires a different scale. To set a new scale, press a key to interrupt the measurement, then restart the measuring and answer NO on the 'Accumulate new measurement data to graph on screen? Y/N' question.

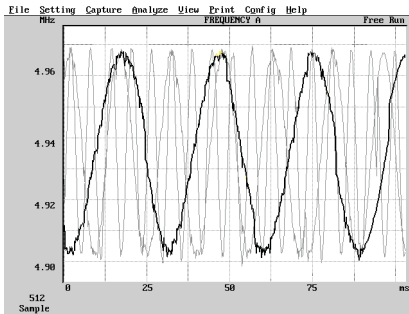

Figure 8-2 Here you can see Multiple graphs on top of each other.

■ Draw Style

Here you can select if the measuring results should be presented as dots, dots with interconnecting lines or just as lines.

Dots is the “correct” way to present this kind of sampled data since TimeView does not know anything about what happens in between measurements. However, it is easier to see in what order the samples are taken if you can follow a connecting line.

Help

Help

Pressing F1 gives context-sensitive help on the topic you have currently selected. Selecting Help from the Help pull-down menu will give the following list of all short-cut keys.

HELP - KEY DESCRIPTION

ALT: Activate menu bar

ESC: Exit menu. Stop data capture or FFT calculation

F1: Help

F2: Settings

F3: Capture, Free running

F4: Capture, Repetitive

F5: Capture, Waveform

F6: Analyze, Statistics

F7: Analyze, FFT

F8: Analyze, Smoothing

F9: Print graph

^A: View, Active Capt. data

^D: View, Distribution

^F: View, FFT

^T: View, Smoothing

^G: View, Graph info

^L: View, Scale

^Z: Zoom In

^O: Zoom Out

More...

HELP - GRAPH CURSORS

ENABLE CURSORS WITH ANY OF THESE KEYS

<Left Arrow>/<Right Arrow>: Move cursor left/right

<Home>/<End>: Move cursor to beginning/end of graph

<Ctrl>+<Arrow>: Move cursor in big steps

<Shift>+<Cursor Key> or

<Scroll Lock> ON: Move right graph cursor

<#>: Toggle display of X-value / sample number

<Tab>: Move and disable display of statistic parameters in distribution histogram

Press any key to continue

Summary of Shortcut Keys

Press F1 for Help

Press F2 to enter the Counter Setting menu

Press F3 to Capture Free-running measurement

Press Ctrl+ F3 for continuous Free-running measurements

Press Shift + F3 to enter the Capture Free-running measurement menu

Press F4 to Capture Repetitive sampling data

Press Ctrl + F4 for continuous repetitive sampling measurements

Press Shift + F4 to enter the Capture Repetitive sampling data menu

Press F5 to Capture Waveform data

Press Ctrl + F5 for continuous capture waveform capture

Press Shift + F5 to enter the Capture Waveform menu

Press F6 to make a Histogram and Statistics of the Measurement data

Press Shift + F6 to enter the Histogram and Statistics menu

Press F7 to make an FFT of the Measurement data

Press Shift + F7 to enter the FFT menu

Press F8 to Smooth the Measurement data

Press Shift + F8 to enter the Smoothing menu

Press F9 to print the current graph

Press Ctrl + A to View Active Captured data

Press Ctrl + D to View Distribution (Statistics)

Press Ctrl + F to View FFT

Press Ctrl + G keys for Graph info

Press Ctrl + L keys for Scale menu

Press Ctrl + O keys to Zoom Out

Press Ctrl + T to View Smoothing

Press Ctrl + Z keys to Zoom in

Press # key to view sample number instead of measurement results on the X-axis

Capturing Data

Preparing a Measurement

To be able to capture data correctly, it is essential that you program the counter as accurately as possible to perform the capture. All programming is done via the TimeView Setting Menu in an easy interactive manner. This manual briefly describes the different settings, but you must use the Operators Manual to gain knowledge about how to set up the counter correctly for all different measuring functions.

Setting up the Timer/Counter

Counter Setting Menu

Use this menu to set up the timer/counter for the measurement.

F2 opens the setting menu.

■ Measurement readout

This is an on-line display of measured value. Check here that the reading is relevant before performing actual data capture.

■ Measuring Function

Select which measuring function the counter should perform, and on which channels.

- All front panel accessible functions except Manual Totalizing and Volt maximum/min measurements can be selected.
- “Totalized Timed” is used to totalize events up to the maximum measuring time (400 s).

Measuring Time

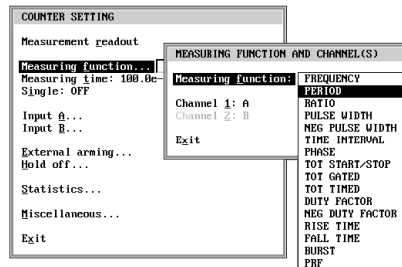

Select the counter's measuring time to get the optimum balance between resolution and speed.

The default measuring time is 100 μ s. In frequency measurements, this gives 8 digits of resolution for each measurement result in the graph. Decreasing the measuring time will decrease resolution.

Measuring speed

The measuring speed (free-running) can be calculated as approximately:

$$\frac{1}{120\mu\text{s} + \text{measuring time}}$$



Try using a short measuring time, in the range 80 ns to 100 μ s. A short measuring time enables TimeView to follow fast variations in the signal. The need for high resolution decreases when you can view the measurement results in a graph, and the smoothing function averages the results to further increase the total resolution. Measuring times less than 5 μ s will not increase the measuring speed of TimeView.

When analyzing the data, you can easily smooth a signal with too many samples, but you can never add samples that were never taken!

Finding Modulations

To find a modulation frequency, the minimum number of samples must be two per modulation cycle. A correct measurement time (when the deviation can be measured within 2 %) can be calculated from the formula:

$$13 \times 10^{-9} \times \frac{F_o}{F_d} < \text{Meas. Time} < \frac{1}{10 \times F_{mod}}$$

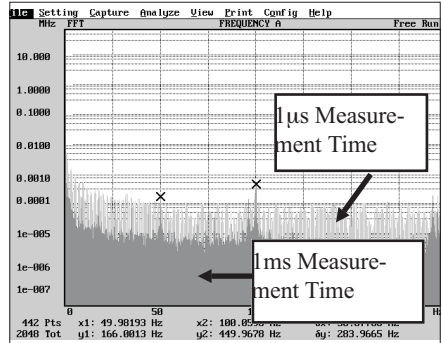

When using a too short Measurement Time (1 μ s in this graph), the modulations (50 & 100Hz) almost disappear in the noise (light gray FFT). At 1ms however, they are clearly visible. (Dark gray FFT).

Example: $F_o = 200 \text{ MHz}$; $F_d = 100 \text{ kHz}$;
 $F_{mod} = 100 \text{ Hz}$
 $26 \mu\text{s} < \text{Meas. Time} < 1 \text{ ms}$

This will be read as: Meas. Time must be greater than 26 μ s and lower than 1 ms (have a value between 26 μ s and 1ms).

Single

Switches on and off averaging.

When SINGLE is ON, the measuring time is used as "Time between measurements". Then measurement speed is approximately

$$\frac{1}{\text{signal cycle time} + \text{measuring time}}$$



Single means measuring one input cycle, with the following exceptions: In Frequency A measurements, SINGLE means four input signal cycles. In FREQ C measurements, SINGLE means 16 cycles.

– Select "SINGLE OFF" (default) to perform average measurements over the set

- measuring time, e.g., Frequency A and Time Interval A-B measurements.
- Select “SINGLE ON” to perform single-cycle measurements, e.g., single-shot Time Interval A-B.
- Always set “SINGLE ON” for jitter measurements.

■ Input A...

Here you select, for instance, input A impedance, coupling, trigger level, and slope.

Signal readout

Choose “Signal Readout” to see the most important pulse signal parameters on input A:

- Period.
- Pulse width.
- Volt maximum and minimum.

This information makes it easier to do the following:

- Set correct measuring time.

- Set correct trigger levels. Note that Vmaximum/Vmin readout may be false if the pulse period is >10 ms.
- Verify input impedance. A voltage indication that is too high may indicate overshoot due to impedance mismatch. If this is the case, select 50 Ω input impedance. A voltage indication that is too low indicates that the counter’s input is loading the signal source too much. If this is the case, select 1MΩ input.

Trigger level:

Enter AUTO (or simply type A) or the numerical value. Millivolts are entered as E-3 or by appending m to the value.

AUTO does not slow down the measurement speed since it makes a single auto trigger level calculation before the data is captured.

Slope:

Toggle between positive or negative trigger slope.

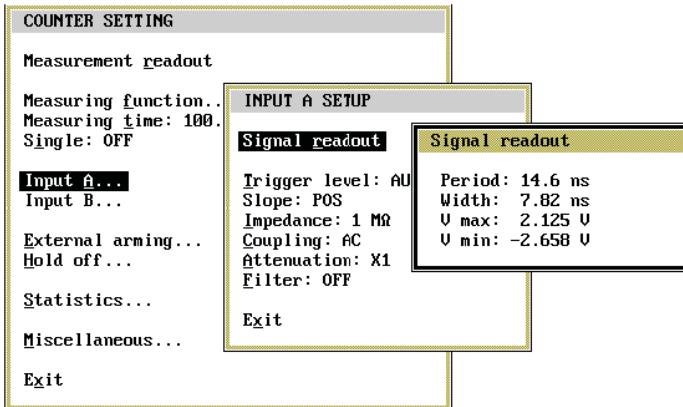

Figure 8-3 If you select signal readout in the input A or B menus, TimeView measures the period, pulse width, and maximum and minimum voltage and shows them all on the screen. This is useful for selecting measuring time, trigger level, and sampling interval, for example.

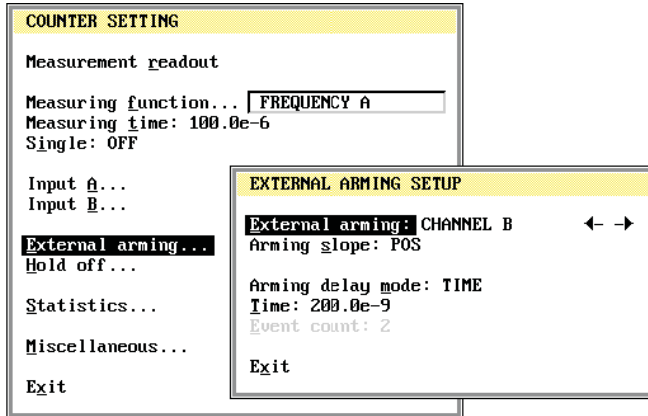

Figure 8-4 In the External Arming Setup window you can activate external arming and set the arming parameters. Use arming when you need to synchronize the measurement with an external trigger event.

Impedance:

Toggle between 1 M Ω or 50 Ω input impedance.

Coupling:

Toggle between AC or DC coupling.

Attenuation:

Toggle between no attenuation (1X) and ten times attenuation (10X). A “10X”-setting increases trigger level range from $\pm 5V$ to $\pm 50V$. This selection has no effect on the counter if the AUTO trigger level is set.

Filter:

Switches on and off the 100 kHz low-pass filter. Turn the filter ON only when you need to reduce the influence of noise on the signal. Always turn the filter OFF when you are measuring rise time or phase.

■ Input B...

This menu has the same choices as Input A, except that there is no filter on the B input.

Common via A:

Feed input A signal to input B also. Use this function instead of external T-piece-connection in time measurements between different points within one signal. Also use COMMON via A when the measurement signal itself shall be used as an arming signal, then measurements are performed on input A and arming on input B.

When COMMON via A is on, the counter ignores the following input B settings and uses the settings for input A instead:

- Coupling.
- Attenuation.

(Impedance B is not used for the measurement but is still used as termination for any signal connected to input B)

■ External Arming...

Use external arming to synchronize the measurement start with an external event.

You can delay the measurement start by a preset delay time or by a preset number of events

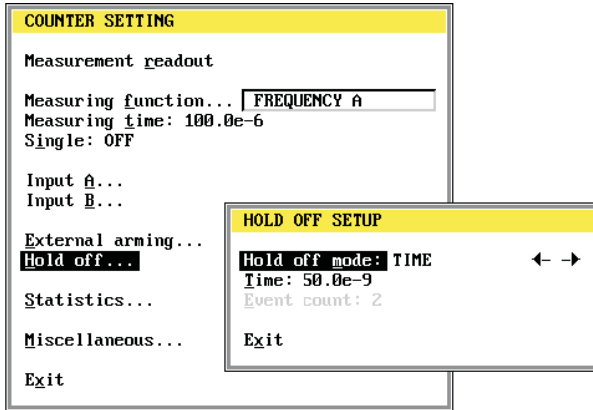

Figure 8-5 In the Hold Off Setup window you can turn the hold off function on or off and select hold off by time or by event counts. You can also set the hold off time and number of events to count. Use hold off to eliminate the influence of contact bounces, ringing, and HF-noise.

after an external synchronization event occurs.

The actual ARMING function behavior will depend on the data capture mode:

- In Free-run Single Block data capture, arming will arm the whole block of measurements.
- In Free-run Multiple Block data capture arming will arm each individual block of data.
- In Repetitive Sampling data capture, all arming settings are controlled from the “Capture repetitive Sampling data” menu.
- Used as external trigger in Waveform capture.

External arming:

Choose between:

- No arming (OFF).
- Arming signal on rear arming input E.
- Arming on front input B.

Input B is the recommended arming input.

The measurement signal itself can be used as the input B arming signal by selecting COMMON VIA A in the INPUT B SETTING menu.

Use input E only in measurements that need input B as measuring input, i.e. TIME A-B, PHASE A-B, RATIO A/B, RATIO B/C, TOT A GATED BY B and TOT A START/STOP BY B.

Arming slope:

Toggle between positive and negative arming slope.

Arming delay mode:

Specify a delay between the external arming signal trigger event and the actual counter arming.

Choose between:

- No delay (OFF).
- Arming delayed by a specified time (TIME).

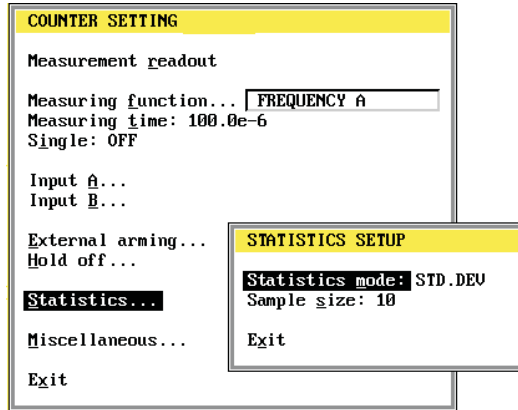

Figure 8-6 In the Statistics Setup window you turn the internal statistics function in the timer/counter on and off and set the sample size. Use this function for example to make average measurements over long periods. Or use maximum or min to let TimeView show and analyze the drift of the RMS-jitter. TimeView can also calculate the mean of the Maximum values to increase resolution.

- Arming delayed by a specified number of trigger events on input B (EVENT COUNT B).

Time:

The TIME delay between external arming event on the selected input (B or E) and the actual arming of the counter can be set between 200ns and 1.6s in 100ns steps.

Event count:

The EVENT COUNT B delay can be set as an integer number between 2 and 16777215. The negative slopes on input B are always counted. If input E is selected as external arming input, the arming signal on input E enables the event counting on input B. Events are never counted on input E!

Using EVENT COUNT B delay, arming can be set up to measure e.g., the width of then:th pulse in a pulse train, by setting Counts = n-1.

■ **Hold Off**

Use Hold Off in TIME measurements to eliminate effects of signal distortion caused by such things as contact bounces.

Hold Off in FREQ A measurements can be used as low-pass filter (Set Hold Off time to $\frac{0.75}{LF \text{ frequency}}$)

Hold Off duration can be defined as a time delay or an event count delay.

Hold Off mode:

Choose between:

- No Hold Off (OFF).
- Hold Off delay by a specified time (TIME).
- Hold Off delay by a specified number of negative slope trigger events on input B (EVENT COUNT B).

Time:

TIME delay for Hold Off can be set between 50ns and 1.34s in 10ns steps.

Event count:

EVENT COUNT B delay can be set as an integer number between 2 and 16 777 215. Trigger events are always counted on input B.

■ **Statistics...**

Here the counter delivers preprocessed statistical values (mean, min/maximum, or standard deviation), instead of individual measurement results, as input data to TimeView.

Free-run Multi-block mode has to be used when capturing and each arming event will trigger one block of the size “Sample size”.

Note that Statistical post-processing of TimeView data is made in the ANALYZE-STATISTICS menu.

Statistics mode:

Choose the type of measurement data that TimeView shall capture between:

- Individual measurements (OFF).
- Mean value of a cluster of counter measurements (MEAN).
- Standard deviation in a cluster of counter measurements (STD.DEV).
- Maximum Value in a cluster of counter measurements (MAXIMUM).
- Minimum Value in a cluster of counter measurements (MINIMUM).

Sample size:

Here you set the sample size for the cluster of measurements when any statistics function in the counter is set. Range 1 to 65 535.

Miscellaneous

Here you toggle between INTERNAL/EXTERNAL timebase reference and set the Minimum frequency for auto trigger, and voltage max/min measurements.

Default Counter Setting

Returns the counter to the TimeView default settings:

- Function: FREQUENCY measurements on input A.
- Measuring time: 1 μ s.
- Input impedance: 1 M Ω .
- Input coupling: AC.
- Trigger level: AUTO (works for signals >100Hz).
- Trigger slope: Positive.
- 100 kHz filter on input A: OFF.
- Hold-Off, Arming, Statistics: OFF.
- Reference oscillator: Internal
- Minimum frequency: 100Hz

Capture

Free-Running Measurement

Measures the variations of the measured parameter in real time.

F3 starts a free-running measurement with the current settings.

ESC. stops the measurement .

Shift + F3 opens the Capture Free-running menu.

Ctrl+F3 starts continuous free-running measurements with the current settings.

■ Single Block

If you select SINGLE BLOCK in the “Capture free-running measurement” menu, the timer/counter makes one block of measurements containing the number of measurements you specify as “Number of samples”. If arming is on, it arms the complete measurement block. The counter free-runs within the block with the measuring speed set by measuring time. Use single block for measurements such as jitter.

■ Multiple Block

If you select MULTIPLE BLOCK, the counter makes several measurement blocks. The block separation can be set by the BLOCK DELAY TIME and by events on the external arming input.

The number of samples made by the counter is the number of blocks multiplied by the block size. If you change the number of blocks or the block size, TimeView calculates the number of samples and shows the total on the display. When statistics capture is selected (in the setting menu), one statistics measurement per block is made, i.e., the block size is not used.

Using Block Delay Time

The measurement blocks are separated by the time you enter as Block Delay time.

Use multiple block mode together with block delay time to measure long term variations, e.g., warm-up, or frequency drift over 48 hours.

The block delay time range is 0 (as fast as possible) and 100 ms to 3600 s.

If you enter a block delay time, TimeView draws the graph sample by sample instead of waiting until all samples are taken.

If the block delay is 1s or more, TimeView will ask you if you want to save the samples on disk. By saving to disk you can avoid that a long measurement is destroyed by for instance power failure.

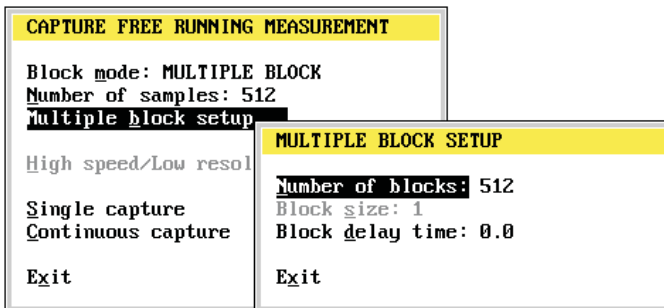

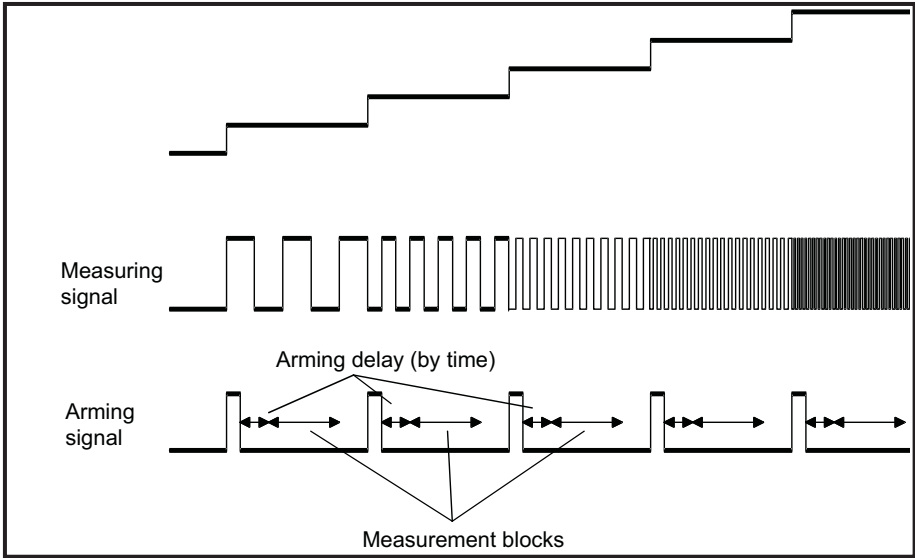

Arming

When arming is on, TimeView triggers the measurement when the block delay time has expired, then the arming conditions must be fulfilled before a measurement block will start. Each measurement block will be armed separately. Setting the block size to 1 will result in each measurement being armed.

Use Multiple block with arming to study several frequency shifts in one measurement sequence. (One frequency shift per arming condition).

■ High Speed/Low Resolution

Use High speed/Low resolution to measure on every period of the input signal. Frequency, Period, Positive and Negative Pulse Width and Time Interval are the allowed measuring functions.

Measuring speed: Frequency and Period up to 40 000 measurements/second.

Positive, Negative Pulse Width or Time Interval up to 20 000 measurements/second.

The C-channel can not be used. External arming, Hold off, Statistics and Multiple block is not possible.

■ Measuring Speed

Maximum data sampling rate is as follows:

- 8500/s for Frequency, Period, Ratio, Totalize.
- 6000/s for Time Interval, Pulse Width, Rise Time.
- 500/s for Phase or Duty Factor.

Maximum number of samples for maximum capture speed:

- 6143 for Frequency, Period, Ratio, Totalize, Phase, Duty Factor.
- 4466 for Time Interval, Pulse Width, Rise Time

■ Calculation of the Time Scale

TimeView places the samples on the time axis in the graph according to the time stamping information it gets from the counter. This gives very good time scale accuracy, even on non-continuous signals.

Repetitive Sampling Data

F4 starts repetitive sampling with the current settings.

Ctrl + F4 starts continuous repetitive sampling with the current settings.

ESC stops the measurement.

Shift + F4 opens the Capture Repetitive sampling menu.

If you select Repetitive sampling data in the capture menu, TimeView Measures the variations of the measured parameter through repeated measurements. TimeView delays the start of each measurement relative to a synchronization signal. The delay is incremented between each measurement. This data capture mode requires a repetitive signal with periodic variations and a synchronization signal.

The sync signal can either be an external signal fed to the arming input or a unique trigger point in the measurement signal itself.

As an example use this function to capture the frequency response of a fast VCO.

■ Increment Setup

is the size of the increment. The minimum time step is 100 nanoseconds, that is maximum virtual data sampling rate is 10,000,000 samples/s. Start time and *stop time* set the lower and upper limits of the sampling.

■ Time Scale Accuracy In Repetitive Sampling

The start time entered in the “DELAY TIME INCREMENT SETUP” window is used as start time in the graph. The first sample is placed here. The subsequent samples are placed at even distances where the distance is equal to the time step. The graph ends at the delay where the last sample is enabled.

Provided that the measurement starts directly after the arming delay, the time scale is very accurate (inaccuracy $< \pm 100\text{ns}$). Since this capture mode is intended for high-frequency modulated events, this gives a very accurate timebase in any normal application.

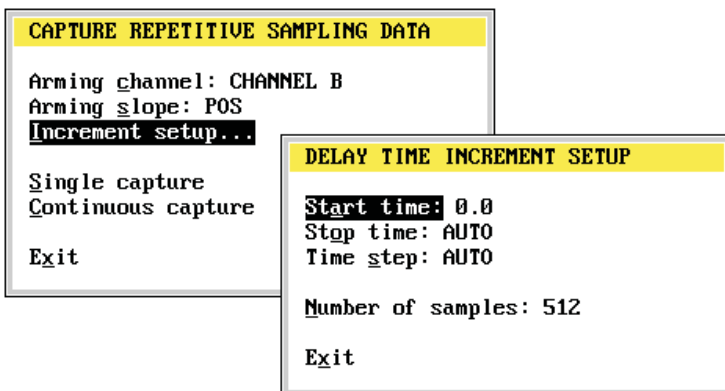

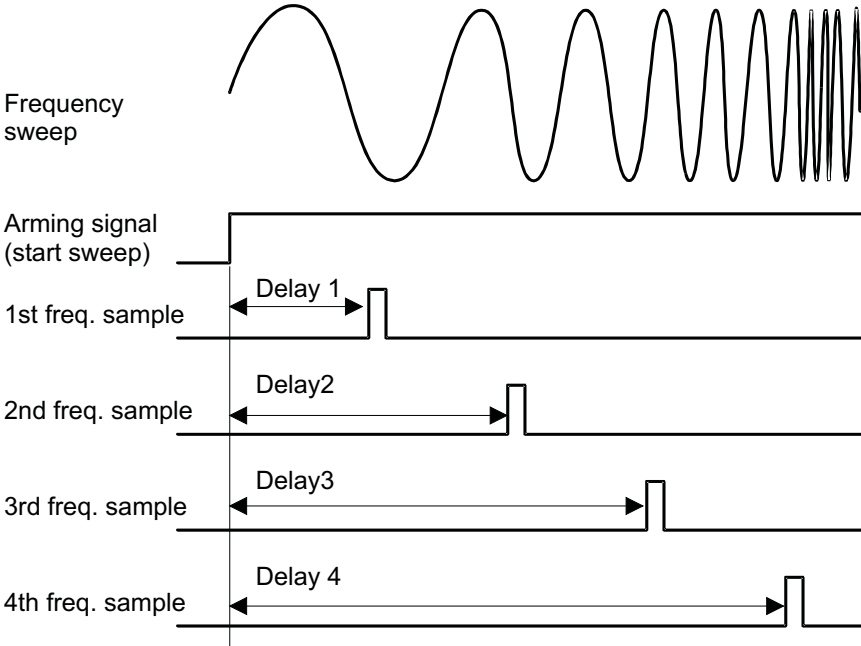

Figure 8-7 TimeView delays the start of each measurement relative to an arming signal. The delay is incremented between each measurement.

Characterizing bursts

If the start time plus one time step does not result in a measurement start delay that is longer than the time between the sync signal and the trigger point of the first pulse in theburst, the counter measures the first pulse of the burst several times, see Figure 8-7.

Time jitter

If there is a time jitter in the delay from the arming signal to the measurement signal, this will be seen as a jitter along the y-axis.

Waveform Data

If you select Waveform data from the capture menu TimeView acts like a normal oscillo-

scope and presents an amplitude/time diagram of the signal. Only repetitive signals can be captured.

TimeView steps the trigger level and checks when the signal triggers on each trigger level step. The time at which the signal triggers on the different trigger levels are recorded and then sorted and displayed. Positive transitions are shown as / , and negative transitions as \ .

This mode can be used between 10 Hz and 50 MHz.

Sweep Setup

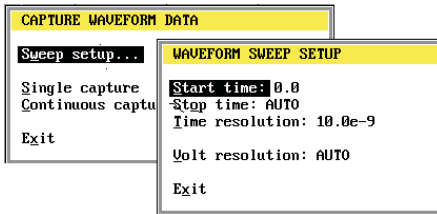

External Trigger. If you turn on external arming in the Configuration Menu, it is used as an external trigger. Only the channel selection in the external arming setup is used.

Start time selects when to start measuring, 0 means directly after the signal passes the set trigger level.

Stop time is set to AUTO by default. Then the sampling will stop after two cycles of the input signal. If you select stop time yourself, you can see more or fewer cycles.

Time resolution selects the time step between samples. This can be used to limit the number of samples on noisy signals.

Volt resolution selects the step size for the trigger level steps. If this parameter is too small, the number of samples on a noisy signal can be very high, causing a too long capture time. AUTO gives approximately 50 vertical points.

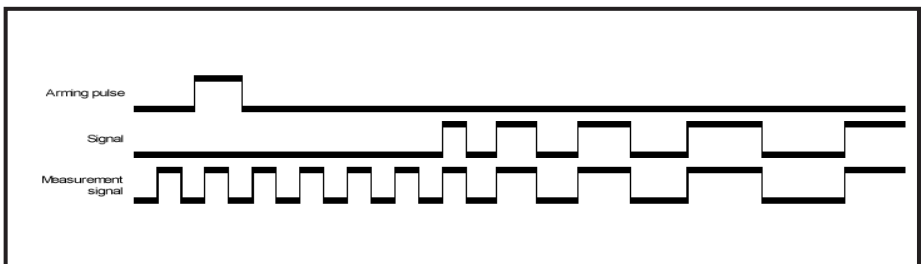

Figure 8-8 The first pulse can be measured several times if time-step is too small.

Analyzing Data

Statistics

F6 starts statistical calculations with the current settings.

Shift + F6 opens the Statistics menu.

Shows a distribution histogram of the measurement data. TimeView shows Maximum, minimum, mean, standard deviation and Root Allan variance of the data in the histogram.

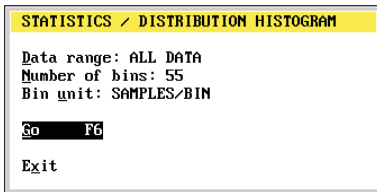

- The Mean value, adds more resolution digits
- The Standard Deviation, gives a direct RMS-jitter read-out, including both jitter and drift
- The Maximum and Minimum values give extreme values in sample

- The Root Allan Variance presents a measure of short term jitter without influence of drift

Data Range

TimeView can calculate statistics either on all measurement data or only on the data between the cursors.

To analyze distribution in cyclical events, such as FM-modulated signals, position graph cursors to cover an integer number of modulation cycles and set “Data between cursors” in this menu.

To analyze distribution in signals with random deviations, set “All data” in this menu.

Number of Bins

“Number of bins” sets how many equally sized bins the samples should be divided into. Default is 55 bins.

To analyze a part of the histogram, to rule out extreme values for example, or to study a sub-cluster in the total data sample, first position the cursors around the bins to be analyzed, then select “ZOOM IN” (**Ctrl+Z**). Now TimeView recalculates the statistical pa-

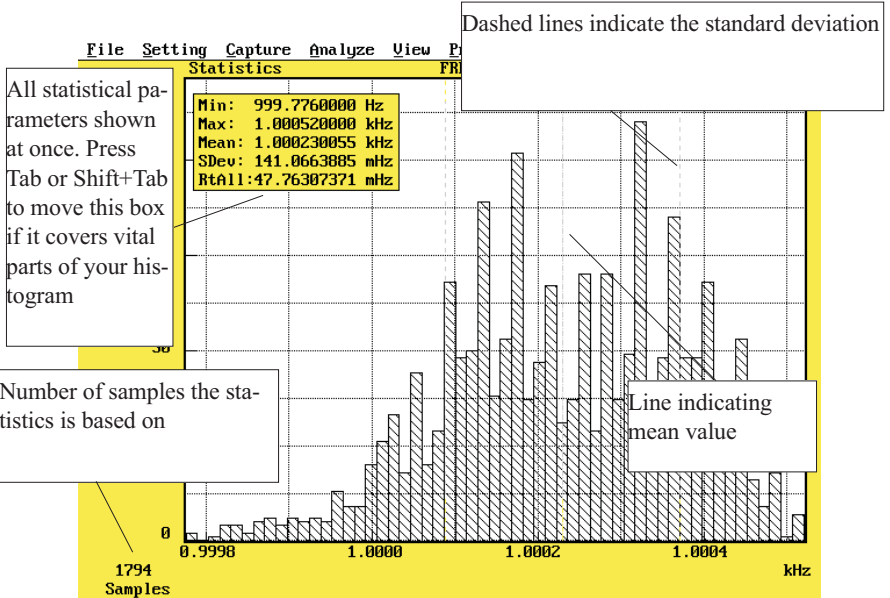

parameters based on the samples in the selected bins.

Bin size

Sometimes you may want a bin to cover a specific range. Then you can calculate the bin Size, as:

$$\frac{X_{Max} - X_{Min}}{\text{Number of bins}}$$

Now use Scaling in the View menu and enter X-Maximum and X-min as manual scale endpoints.

Bin Unit

Choose between display of the number of measurement samples per bin (SAMPLES/BIN) or the relative percentage of the number of values per bin (PERCENT/BIN).

Scale

If you select "Scale Accumulate Graph: Multiple" in the View pull-down menu, statistics will be performed on the total amount of data captured in multiple measurements.

If you zoom in an accumulated histogram, the statistical parameters will not be recalculated to reflect the selected bins. This is because only the number of samples / bin are kept in memory, not all measuring results from all accumulated measurements.

Fast Fourier Transform

F7 starts FFT calculation with the current settings.

ESC stops the FFT calculations.

Shift + F7 opens the FFT menu.

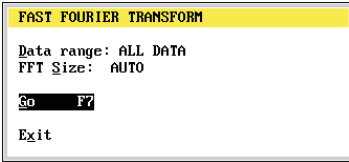

Calculates the FFT (Fast Fourier Transform) of the measurement data and displays it in a graph. TimeView can calculate either on all measurement data, or only on the data between the cursors. A Fast Fourier Transform (FFT) function is used to detect modulation, whether intentional or unwanted. FFT analysis gives an indication of both the modulation frequency and the corresponding deviation of the carrier frequency.

Cursors

You can perform FFT on all data or on data between cursors. In modulation analysis on FM signals, always position the graph cursors to cover an integer number of modulation cy-

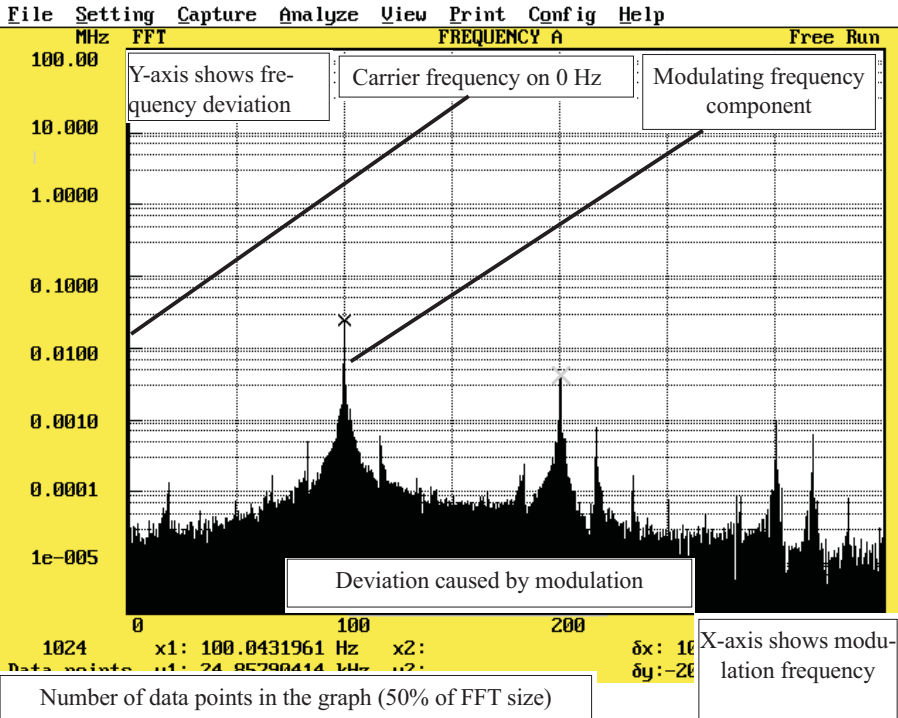

cles, and select DATA BETWEEN CURSORS in this menu.

FFT Size

AUTO FFT size makes TimeView select the closest power of two FFT size above the sample size, or, if the sample size is a power of two, it sets the FFT size to the sample size.

■ Selecting FFT Size Manually

An FFT can be made only on data that contain a number of samples that are equal to a power of two (2, 4, 256, 512, and so on). The TimeView solution to this problem is to map the captured data onto a power of two equidistant point scale, using linear interpolation. This means that if you set the FFT size manu-

ally, you should set it greater than or equal to the number of captured samples. An even better solution is to select the captured number of samples as a power of two, otherwise the calculation may lead to aliasing (see below).

Aliasing

TimeView does not use any anti-aliasing filter, this means that frequencies above the sampling frequency divided by two will be aliased into the FFT diagram. To minimize the effect of aliasing, you should use the longest measuring time possible that allows you to see the modulation frequencies that you are interested in. The averaging obtained by using a longer measuring time will act as a low-pass filter. To check which frequency components are cor-

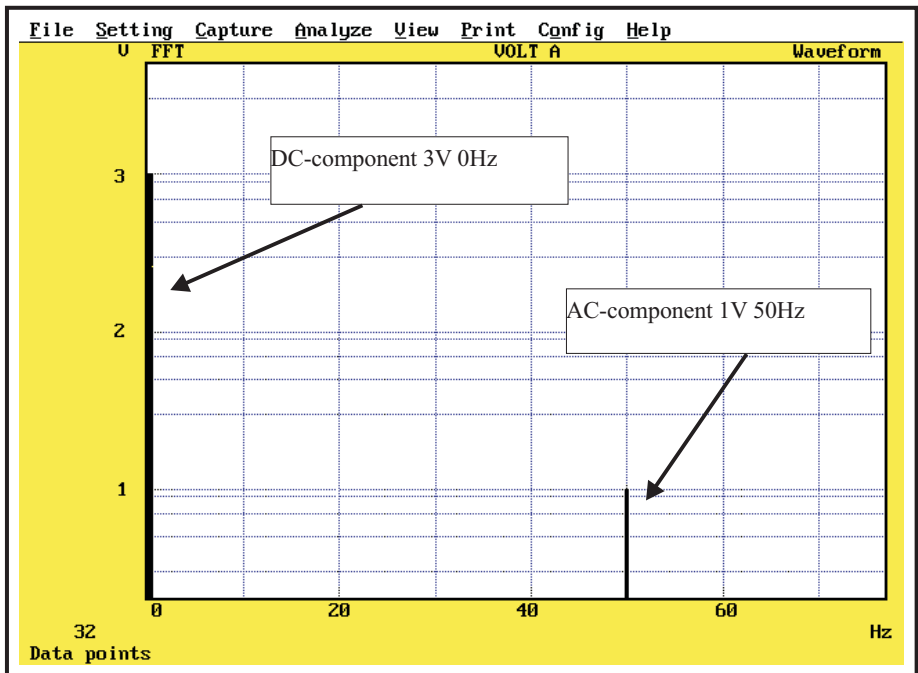

Figure 8-9 FFT of the voltage in the above graph gives this voltage versus frequency graph.

rect and which are aliased, change the sampling interval a little (the measuring time for “free-running” measurements). The frequencies of the aliased components will then change while the correct components will retain their frequencies.

Fast Fourier Transform (FFT) Basics

TimeView calculates FFT in a similar way to FFT analyzers or DSO’s. However, TimeView gives a transformation of sampled frequency or time data instead of sampled voltage data.

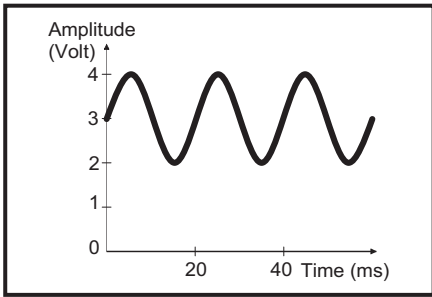

Figure 8-10 Voltage versus time graph from a DSO (or TimeView LF-volt!).

The FFT transforms sample data over time to its constant component value and to the various sinusoidal components, of which the measured parameter is composed. In other words: FFT transforms sample data to its DC value and to the AC sinusoidal variations superimposed on it.

All these signal components are shown in an X-Y graph. See 8-10 and 8-11. The Y-value represents the amplitude of each component; X represents the frequency of the signal component.

FFT of Voltage/time gives an X-Y graph with bars for the DC voltage and for each sinusoi-

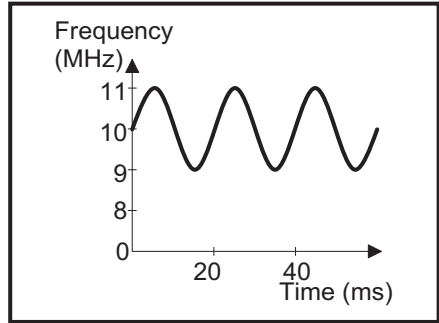

Figure 8-11 Frequency versus time graph from TimeView.

dal AC element. Y represents the amplitude and X represents the frequency.

FFT of Frequency/time gives an X-Y graph with bars for the constant frequency component (carrier frequency), and for each frequency variation (AC element). The Y-value represents the measured frequency variation and X represents the frequency of the frequency variations.

■ Remember:

- The constant component value of a frequency is called carrier wave or CW.
- A systematic frequency variation of a frequency is called modulation.
- The magnitude of this frequency variation is called frequency deviation.
- The frequency of the frequency variation is called modulation frequency.

FFT of Frequency/time shows thus an X-Y graph with bars for the carrier wave frequency (no variation; X = 0 Hz) and for the modulation frequencies.

If a pure sine wave modulates the signal (no frequency noise), only one additional point will be present, like in Figure 8-10 . If the

modulation signal has also higher harmonics, more points will be present.

Since phase noise and residual FM are always present to some extent, a certain minimum level of random interferences is also always present in the FFT graph.

The visibility of weak modulations depends on the scale sensitivity of the FFT software package.

As in most FFT analyzers, TimeView also features a logarithmic scale. This enables simultaneous view of very small modulations and the carrier wave frequency.

■ Accuracy

The accuracy of the FFT graph in TimeView depends mainly on the following three factors.

- sample density per modulation cycle
- sample density over time
- measuring time for each sample

Sample density

In the Frequency versus time graph , we see the frequency varying between a maximum and a minimum value.

The transformation data can never be more accurate than the raw frequency versus time data from which it was obtained. To identify accurately the Y- and X-values of the min/maximum deviation points, depends on how close

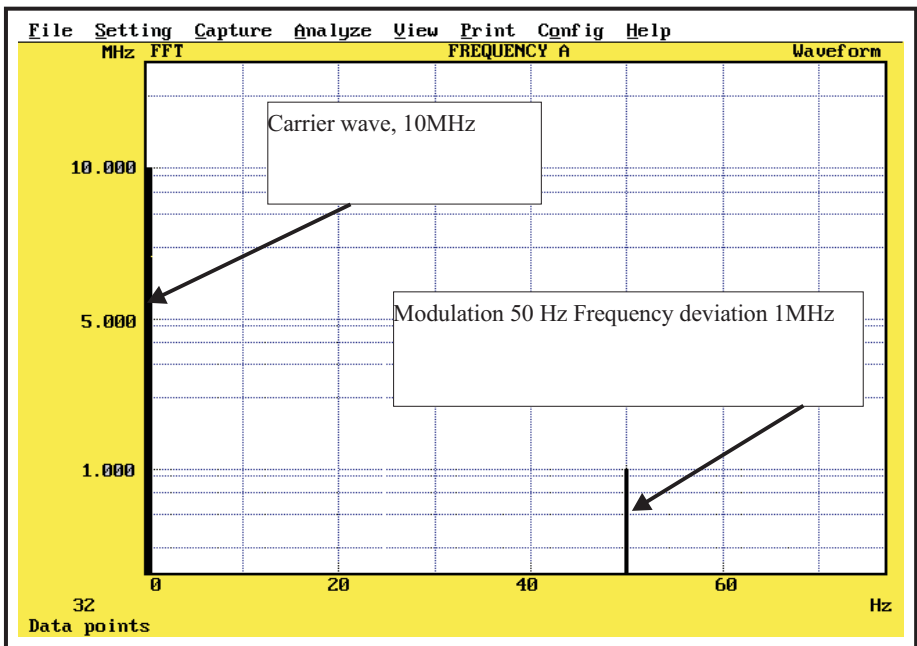

Figure 8-12 FFT of frequency gives a Deviation frequency versus Modulation frequency graph.

samples were taken at the actual min/maximum deviation points.

After transformation, the accuracy of the Y-scale (frequency deviation) and the X-scale (modulation frequency) depends on how many samples were taken per modulation cycle.

If the sampling covers more than one modulation cycle, the FFT transformation must be done over an integer number of modulation cycles.

In TimeView, this can be done through transformation of data between cursors. The second cursors must be positioned at the same place of the modulation as the first cursor.

■ Sample Frequency

Free-Running Mode

In the (real-time) free-running mode, the number of samples taken per second defines the sample density over time. This sample density over time defines how fast a frequency variation can be and still be shown. Generally the sample frequency must be more than twice the modulation frequency, but that should be observed.

In the best case, the counter can take 8500 samples/s. Therefore, in free-running mode, TimeView's FFT mode can reveal modulations only below 4.25 kHz.

Repetitive Sampling

In the repetitive sampling mode, the arming delay steps define the sample density over time. The counter's + TimeView's minimum increment is 100 ns, which equals 10 M samples/s. You must therefore use repetitive sampling mode to analyze high modulation frequencies.

Y-Scale Accuracy

The Y-scale shows the maximum deviation frequency that occurs.

To obtain the extreme frequency values during modulation, the selected measuring time must be sufficiently short. A measuring time that is too long causes the frequency to be averaged during a part of the modulation cycle. (See "FM measurements" in the Measuring Functions Chapter of this manual). If the measuring time is longer than the modulation frequency, the modulation will not show at all in the FFT.

For reliable FFT Y-scale readings, the measuring time should be:

$$\frac{1}{10 \times \text{Modulation Frequency}}$$

Longer measuring times still allow you to detect modulations but give a too low deviation value on the FFT screen. A longer measuring time lowers the displayed deviation.

To measure the modulation with an accuracy of 2 %, the measuring time must be :

$$13 \times 10^{-9} \times \frac{F_o}{F_d} < \text{Meas. Time} < \frac{1}{10 \times F_{mod}}$$

*Example: $F_o = 200 \text{ MHz}$; $F_d = 100 \text{ kHz}$;
 $F_{mod} = 100 \text{ Hz}$
 $26\mu\text{s} < \text{Meas. Time} < 1\text{ms}$, i.e., the measuring time must have a value between 26 ms and 1ms.*

Smoothing

F8 starts smoothing calculations with the current settings.

ESC stops smoothing calculations.

Shift + F8 opens the smoothing menu.

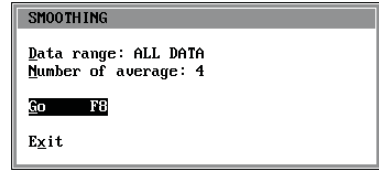

The original data is not overwritten, so it is “safe” to perform smoothing.

Calculates the moving average over the number of samples selected by number of average. You can smooth the entire range or just the data between the cursors. Use Smoothing to average out noise and jitter in the original measurement and to reveal underlying trends in the graphic presentation of measurement versus time.

Number of Average

Enter the number of samples per average here. Use as few samples per average as possible to remove the noise. Taking too many samples per average will also remove relevant signal information.

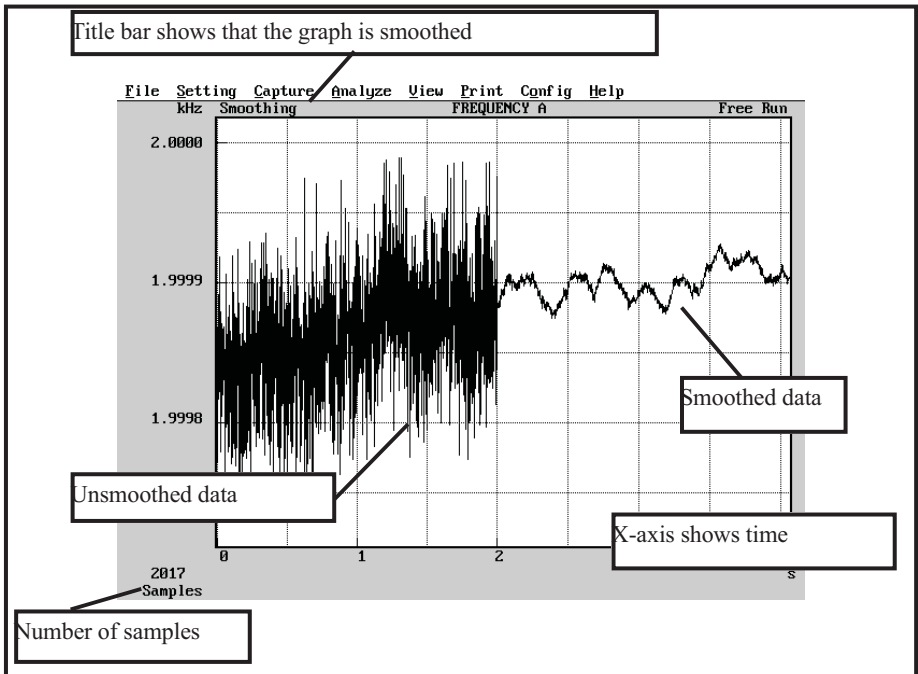

Figure 8-13 Smoothing data makes it easier to see trends.

Saving and Printing

File

Default settings

Sets all TimeView settings to Default. The settings in the Config menu are not affected.

Save / Retrieve

Saves and retrieves measurement data and settings.

The files have the following extensions:

- .SSD Free-running measurement
- .RSD Repetitive sampling data
- .WAD Waveform data
- .SET Setting files

In addition to the measurement data, the files also contain the date, time, and counter settings for the measurement.

Settings include all counter settings and the parameters in the capture and analyze menus. The settings also include the graph scale coordinates for all the graphs.

TimeView can remember the setting it had when turned off. You can select to start with

the previous settings in the Config menu. These previous settings are stored in the file `TIMEVIEW.SET`.



You may load a file when starting TimeView by appending the file name to the start command.

Example: `TimeView WARMUP.SSD`

The TimeView File Format

■ Setting files

The set files are ASCII text files. By reading a SET file in a text editor you can see which version of the TimeView SET-file format this is.

Example:

```
# Fluke, TimeView V2.0X
1.000000e-004, 0, 0, 1, 0
AUTO, 0, 0, 0, 0, 0
AUTO, 0, 0, 0, 0, 0
.....
```

■ Data Files

TimeView stores data on the disk as an ASCII text file. The file begins with the counter settings used followed by two columns of digits separated by a space character. The data files can easily be imported into spreadsheet pro-

grams such as Lotus 123 and Excel, if you want to analyze the data further.

■ Extracting Setting Information From a “.SSD” or “.RSD” File

You can use the counter settings stored in a “.SSD” or “.RSD” file to repeat a measurement for which you don’t have a “.SET” file:

- Select Retrieve Settings from the File menu.
- Move to the directory where you have the “.SSD” or “.RSD” file, and enter *.SSD or *.RSD at the end of the command line.

Setting data

Your own comments on the measurement

Graph

Now the available files are listed on the screen and you can select the one you want.



Only counter settings can be retrieved this way; the TimeView settings must be entered manually.

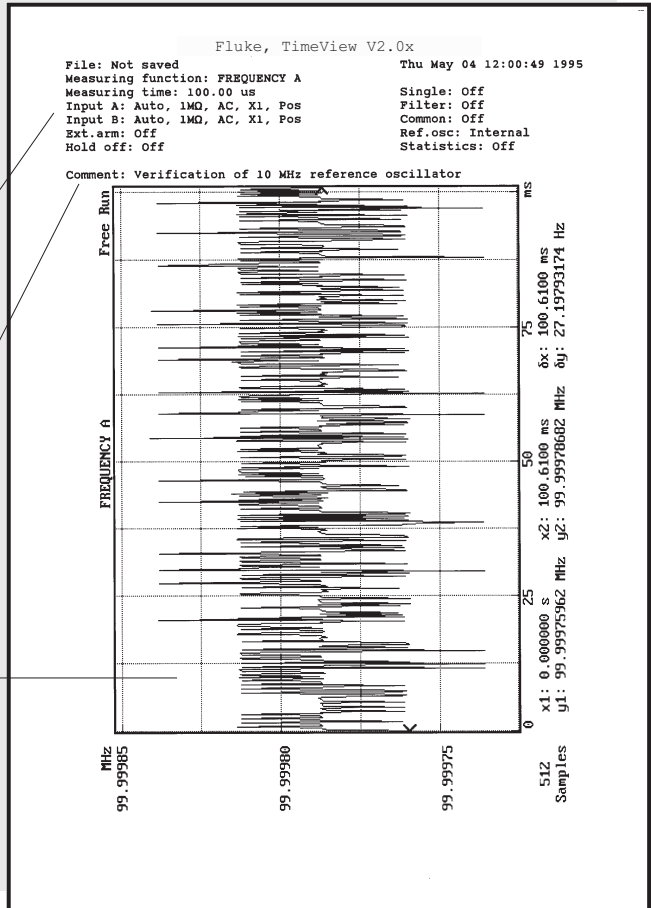

Example

```
# Fluke, TimeView V2.0X
# FREQUENCY A
# Tue Sep 07 11:45:09 1993
# Measuring time: 100.00 us
# Input A: AUTO, 1 MΩ, AC, X1, POS
# Input B: AUTO, 1 MΩ, AC, X1, POS
# Ext. arm: OFF
# Hold off: OFF
0.000000000000e+000 5.484171719018e+007
5.667968653142e-004 5.484129087351e+007
1.133593730628e-003 5.484179657156e+007
1.700390595943e-003 5.484152302190e+007

2.267187461257e-003 5.484181512344e+007
2.833984326571e-003 5.484156087879e+007
3.400781191885e-003 5.484142987951e+007
3.967578057200e-003 5.484165215593e+007
```

Setting information

```
Single: OFF
Filter: OFF
Common: OFF
Ref.osc: INTERNAL
Statistics: OFF#
```

Block separator (new line) in multiple block measurement

X-axis values

Y-axis values

About TimeView

Shows information about TimeView and the connected counter. If you need support on TimeView, always indicate the version numbers and dates shown in this window.

Go to DOS

Go to DOS without exiting TimeView. Use this function if, for instance, you want to delete or copy files without losing your data in TimeView. Type EXIT at the command prompt when you want to return to TimeView.

Exit

Exit from the TimeView program. Remember to store your data before selecting exit.

Print

■ Hard copy

Here you can print the graph on the screen. The printer settings selected in the Config menu will be used.

Use F9 to print the current graph.

Chapter 9

Performance Check

General Information

WARNING: Before turning on the instrument, ensure that it has been installed in accordance with the Installation Instructions outlined in Chapter 1 of the Operators Manual.

This performance procedure is intended to:

- Check the instrument’s specification.

- Be used for incoming inspection to determine the acceptability of newly purchased instruments and recently recalibrated instruments.
- Check the necessity of recalibration after the specified recalibration intervals.

NOTE: The procedure does not check every facet of the instrument’s calibration; rather, it is concerned primarily with those parts of the instrument which are essential for determining the function of the instrument.

It is not necessary to remove the cover of the instrument to perform this procedure.

Test Equipment

Type of Equipment	Required Specifications	Suggested Type
LF Synthesizer	Square; Sine up to 2 MHz	
Digital Multimeter	up to 300 V _{AC} & V _{DC}	
Power Splitter	50 Ω 6 dB BNC	
T-piece	BNC	
Termination	50 Ω feedthrough BNC	
Low pass filter	50 kHz (for 1 MΩ)	
Reference oscillator	10MHz 1*10 ⁻⁸ for std. UCXO or PM9678B	PM6680B/PM6681/PM6685 w. PM9691
	10MHz 1*10 ⁻⁹ for PM9691 or PM9692	PM6685R; PM6681R
HF signal generator	4.5 GHz	
Pulse Generator	125 MHz	
Oscilloscope with probes	350 MHz	
Power Supply	min 40 V _{DC}	
BNC-cables	5 to 7 pcs	

Table 9-1 Recommended test equipment

Preparations



Power up your instruments at least 30 minutes before checking to let them reach normal operating temperature. Failure to do so may result in certain

test steps not meeting equipment specifications.

Front Panel Controls

Power-On Test

At power-on the timer/counter performs an automatic test of the following:

- Microprocessor

- RAM
- ROM
- Measuring circuits

It also displays the GPIB address.

If any test fails, an error message is shown.

Internal Self-Tests

The built-in test programs from the power-on test can also be activated from the front panel as follows:

- Enter the Auxiliary Menu by pressing **AUX MENU**.

- Select the test submenu by pressing **SELECT** up or down.
- Enter the test menu by pressing the **ENTER** key.

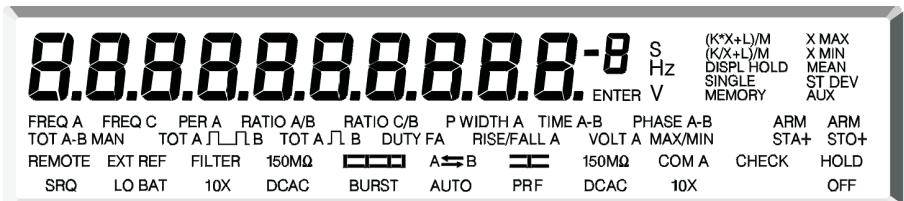

Figure 9-1 Text on the display

Performance Check

Selections for internal self-tests are:

- 1 TEST RO (ROM)
- 2 TEST RA (RAM)
- 3 TEST ASIC (Measuring Logic)
- 4 TEST DISP (Display Test)
- 5 TEST ALL (Test 1 to 4 in sequence)

- Use **SELECT/SET** to select TEST ALL, then press **ENTER**.
- If any fault is detected, an error message appears on the display and the program halts.
- If no faults are detected, the program returns to measuring mode.

Keyboard Test

This test verifies that the timer/counter responds when you press any key. To check the function behind the keys, see the tests further on in this chapter.

Press the keys as described in the first column and look on the display for the text, as described in the second column. Some keys change more text on the display than de-

scribed here. The display text mentioned here is the text mostly associated with the selected key.

NOTE: For the instrument to respond correctly, this test must be carried out in sequence and you must start with the PRESET setting.

Key(s)	Display PM6680B	Display PM6681	Pass	Note
STAND-BY	Display Off	Display Off		Red LED On
ON	☐	-----		Backlight On
PRESET	PrESEt ☐	PrESEt -----		Default setting
EXT REF	EXT REF	EXT REF		
Input A				
FILTER	FILTER	FILTER		
50Ω/1MΩ	50Ω	50Ω		
⌋/⌋	⌋	⌋		
AC/DC	DC	DC		
AUTO	1X	1X		
1X/10X	10X	10X		
SET A 1 . 73	1.73 V Enter	1.73 V Enter		
ENTER	☐	-----		
SWAP A ↔ B	A ↔ B	A ↔ B		

Key(s)	Display PM6680B	Display PM6681	Pass	Note
Input B				
\square/\square	\square	\square		
50 Ω /1M	50 Ω	50 Ω		
SET B 0.98 +/-	-0.98V Enter	-0.98V Enter		
ENTER	0	-----		
AC/DC	AC	AC		
1X/10X	10X	10X		
COM A	COM A	COM A		
HOLD OFF ON	HOLD OFF	HOLD OFF		
HOLD OFF SET	10^{-6}	H. OFF t. i.		
PRESET x 2	PrESEt 0	PrESEt -----		
Other				
TIME	200^{-3} S	200^{-3} S		
SELECT▲	500^{-3} S	500^{-3} S		
ENTER	0	-----		
HOLD	DISPL HOLD	DISPL HOLD		
HOLD				
SINGLE	SINGLE	SINGLE		
◀ FUNCTION	VOLT A MAX/MIN	VOLT A MAX/MIN		
◀ FUNCTION	RISE/FALL A	RISE/FALL A		
FUNCTION▶	VOLT A MAX/MIN	VOLT A MAX/MIN		
FUNCTION▶	FREQ A	FREQ A		
AUX MENU	Last menu used	Addr.		
RESTART	0	-----		
START ARM	OFF	Ar. StA OFF		
RESTART	0	-----		
STOP ARM	OFF	Ar. StO OFF		
RESTART	0	-----		
PRESET	PrESEt 0	PrESEt -----		
CHECK	10. 00000000 ^{6*}	100. 00000000 ^{6*}		Counting

Performance Check

Key(s)	Display PM6680B	Display PM6681	Pass	Note
MATH SELECT▼ ENTER	OFF ON 10. 00000000 ^{6*}	Ar ith OFF Ar ith ON 100. 00000000 ^{6*}		
K= 2	1.0 2	1.0 2		
ENTER	20. 00000000 ^{6*}	200. 00000000 ^{6*}		Counting
L= Xn-1 ENTER	0.0 n-1 30. 00000000 ^{6*}	0.0 n-1 300. 00000000 ^{6*}		Counting
L=	n-1	n-1		
0 ENTER	20. 00000000 ^{6*}	200. 00000000 ^{6*}		Counting
L= Xn ENTER	40. 00000000 ^{6*}	400. 00000000 ^{6*}		Counting
L=	20. 00000000 ^{6*}	200. 00000000 ^{6*}		
4 EE 7 ENTER	60. 00000000 ^{6*}	240. 00000000 ^{6*}		Counting
M= . 5	0.5	0.5		
ENTER	120. 00000000 ^{6*}	480. 00000000 ^{6*}		Counting
STAT	OFF	Stat OFF		
ENTER	120. 00000000 ^{6*}	480. 00000000 ^{6*}		Counting
▲ FUNCTION (6 times)	TOT A-B MAN	TOT A-B MAN		
TOT St/St	Gate LED lit	Gate LED lit		
MENU		Displays all available functions, processes and input controls. Selected items are blinking.		MENU is not disabled by setting DEFAULT, press MENU again.
PRESET	PrESEt 0	PrESEt -----		Default

Table 9-2 Keyboard test

* The LSD digit may vary

Short Form Specification Test

Sensitivity and Frequency Range

- Press the **PRESET** key to set the timer/counter in the default setting.
- Select 50 Ω input impedance and Non AUTO, (X1).
- Connect a signal from a HF generator to a BNC power splitter.
- Connect the power splitter to your counter and an oscilloscope.
- Set input impedance to 50 Ω on the oscilloscope.
- Adjust the amplitude according to the following table. Read the level on the oscilloscope. The timer/counter should display the correct frequency.
- Connect the signal to input B.
- Select 50 Ω input impedance and **SWAP A \leftrightarrow B** on the counter.
- Repeat the above measurements for input B.

Frequency		Level		Pass	
PM6680B	PM6681	mV _{RMS}	dBm	Input A	Input B
1 MHz	1 MHz	20	-21		
50 MHz	50 MHz	20	-21		
100 MHz	100 MHz	20	-21		
200 MHz	200 MHz	30	-17		Channel B 100 MHz
225 MHz		40	-15		
	250 MHz	40	-15		
	300 MHz	60	-11		

Table 9-3 Sensitivity for inputs A & B at various frequencies

Check VOLT MAX/MIN

- **PM6681**
- Set your timer/counter in default setting by pressing **PRESET**.
- Select DC coupling, 1 M Ω input impedance and VOLT A MAX/MIN.
- Disconnect all cables to input A and B, Press **AUX MENU**, select **CAL HYST**, press **ENTER**, re-connect cables to input A and B.
- The counter should now indicate:
 - $V_{MAX} = 0 \pm 0.004$ V and
 - $V_{MIN} = 0 \pm 0.004$ V.

Performance Check

- Connect a 4.00 V_{DC} level to channel A, using an external low pass filter on the input.
- The readings should be:
 $V_{MAX} = 4.00 \pm 0.044$ V and
 $V_{MIN} = 4.00 \pm 0.044$ V.
- Change the DC level to 40 V.
- The counter should indicate:
 $V_{MAX} = 40.0$ V \pm 0.84 V and
 $V_{MIN} = 40.0$ V \pm 0.84 V.
- Repeat the measurement with inverted polarity.
- Press **MATH** and select (K*X+L)/M to change to V_{pp} measurements.
- Press **ENTER**.
- Connect a sinusoidal signal to channel A with an amplitude 4.00 V_{PP} and a frequency of 100 kHz.
- The indication should be 4.00 ± 0.244 V.
- Change the amplitude to 18 V_{PP}.
- The display should read 18.0 ± 1.84 V.
- Select SWAP A \leftrightarrow B, and connect the signal to channel B. Repeat the measurements for B as described above.
- The readings should be:
 $V_{MAX} = 4.00 \pm 0.07$ V and
 $V_{MIN} = 4.00 \pm 0.07$ V.
- Change the DC level to 40 V.
- The counter should indicate:
 $V_{MAX} = 40.0 \pm 1.1$ V and
 $V_{MIN} = 40.0 \pm 1.1$ V.
- Repeat the measurement with inverted polarity.
- Press **MATH** and select (K*X+L)/M to change to V_{pp} measurements.
- Press **ENTER**.
- Connect a sinusoidal signal to channel A with an amplitude of 4.00V_{pp} and a frequency of 100kHz)
- The indication should be 4.00 ± 0.27 V.
- Change the amplitude to 18 V_{PP}.
- The display should read 18.0 ± 2.1 V.
- Select SWAP A \leftrightarrow B, and connect the signal to channel B. Repeat the measurements for B as described above.

■ PM6680B

- Set your timer/counter in default setting by pressing **PRESET**.
- Select DC coupling, 1 M Ω input impedance and VOLT A MAX/MIN, but do not connect any input signal.
- The counter should now indicate:
 $V_{MAX} = 0 \pm 0.03$ V and
 $V_{MIN} = 0 \pm 0.03$ V.
- Connect a 4.00 V_{DC} level to channel A, using an external low pass filter on the input.

Trigger Indicators and Controls

Manually set trigger level	Trigger indicator PM6680B	Pass	
		Input A	Input B
+1 V	off		
-1 V	on		
0.0 V	blinking		

Manually set trigger level	Trigger indicator PM6681	Pass	
		Input A	Input B
+1 V	steady		
-1 V	steady		
0.0 V	blinking		

Table 9-4 Trigger indicator check PM6680B (above) and PM6681 (below)

NOTE: This test must be performed in the sequence given.

- Press the **PRESET** key to set the Timer/Counter in the default setting.
- Select Non AUTO, X1 attenuation, and 1 M Ω input impedance for channel A.
- Connect the following signal to channel A:
Sine, 10 kHz, 0.9 VPP, and + 0.50 VDC.
- Verify that the three modes for the trigger indicator are working properly by changing the trigger level:
 - Press the **SET A** key and enter 1 via the keyboard, then verify by pressing **ENTER**. Check the trigger indicator according to Table 9-4.
 - Press the **SET A** key and enter -1 via the keyboard, then verify by pressing **ENTER**. Check the trigger indicator according to Table 9-4.
 - Press the **SET A** key and enter 0 via the keyboard, then verify by pressing **ENTER**. Check the trigger indicator according to Table 9-4.
- Connect the signal to channel B.
- Select SWAP A \leftrightarrow B, and AC coupling on channel B, and repeat the exercise for channel B.

Trigger Level Check

- Deselect SWAP A ↔ B, connect the generator to channel A and check the trigger settings and indicators according to Table 9-5.
- Select SWAP A ↔ B
- Connect the signal to channel B.
- Select AC coupling on channel B, and repeat the previous settings for channel B.
- Connect the signal to channel A.
- Only the trigger indicator for channel A should be blinking.
- Press **COM A**.
- Both indicators should be blinking.
- Connect the signal to channel B.
- No trigger indicator should be blinking.

Trigger setting	Trigger indicator	Pass	
		Input A	Input B
SET A = 0 V	blinking		
DC Coupling	steady		
SET A = 0.7 V	blinking		
50 Ω Impedance	steady		
SET A = 0.2 V	blinking		
AC Coupling & 1 MΩ Impedance	blinking		
X10 Attenuation	steady		
SET A = 0.0 V	blinking		
X1 Attenuation	blinking		

Table 9-5 Trigger level check

Reference Oscillators

X-tal oscillators are affected by a number of external conditions like ambient temperature and supply voltage but also by ageing. There-

fore it is hard to give limits for the allowed frequency deviation. The user himself must decide the limits depending on his application,

Oscillator	Frequency readout	Suitable reference	Pass
Standard	10.00000000 MHz ± 150 Hz	PM9691	
TCXO (PM9678)	10.000000MHz ± 12Hz	PM9691	
PM9691	10.00000000 MHz ± 1 Hz	PM6681R/PM6685R	
PM9692	10.00000000 MHz ± 0.25 Hz	PM6681R/PM6685R	
Rubidium (PM6681R)	10.00000000 MHz ± 0.01 Hz	Cesium or 910R (GPS-controlled Rubidium reference)	

Table 9-6 Acceptance test for oscillators

and recalibrate the oscillator accordingly. See Chapter 10, Preventive Maintenance.

To check the accuracy of the oscillator you must have a calibrated reference signal that is at least five times as stable as the oscillator that you are testing, see the following table. If you use a non 10 MHz reference, you can use the mathematics in the timer/counter to multiply the reading.

- Set the counter to default settings by pressing PRESET.
- Connect the reference to input A
- Check the readout against the accuracy requirements of your application.

■ Acceptance Test

As an acceptance test, see Table 9-6, gives a worst case figure after 30 minutes warm up time. All deviations that can occur in a year are added together.

Resolution Test

- Connect a pulse generator to a power splitter.
- Connect one side of the power splitter to the A input of the counter via a coaxial cable.
- Connect the other side of the power splitter to the B input of the counter.

Settings for the pulse generator:

- Amplitude = 1 V_{PP}, (high level +1V and low level 0V)
- Period approx. 1 μs
- Duration = approx 50 ns
- Rise time 2 ns

Settings for the timer/counter, after **PRESET**:

- Function = Time A-B

- Single
- Press **STAT** key under PROCESS
- Press **SELECT** key until display shows ‘ST DEV’.
- Meas Time = 50 μs
- A and B inputs:
 - 50 Ω input impedance
 - Non Auto
 - Trigger level = 0.5V
 - DC coupling

The result should be (std dev) < 0.25⁻⁹ s for the PM6680B, and < 0.05⁻⁹ s for the PM6681.

Rear Input/Output

10 MHz OUT

- Connect an oscilloscope to the 10 MHz output on the rear of the counter. Use coaxial cable and 50 Ω termination.
- The output voltage is sinusoidal and should be above 500 mV rms (1.4 V p-p).
- **PM6681R**
Test all reference outputs, 5 x 10 MHz + 1 x 5 MHz

GATE OPEN Output

- Set your timer/counter to Default Settings by pressing PRESET.
- Select CHECK, AUTO OFF, and Meas Time = 5 ms.
- Connect the oscilloscope to the Gate Open output via a coaxial cable. Set the oscilloscope to 1 ms/division.
- The Gate Monitor output should be a pulse similar to Figure 9-2.

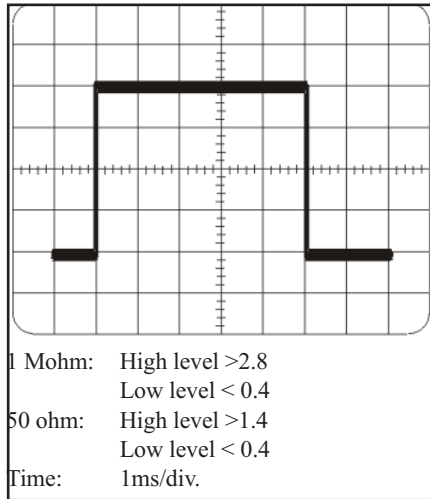

Figure 9-2 Signal on gate open output

REFERENCE IN

■ PM6681

- Set the counter to Default Settings by pressing **PRESET**.
- Connect EXT REF out from another counter to input A.
- Connect a 10 MHz, 200 mV rms, (0.57 V p-p) signal to EXT REF IN at the rear, terminated with 50 Ω .
- Select Ext Ref.
- The display should show 10 MHz.
- Change the reference frequency to 5, 2, and 1 MHz respectively.

- The display should still show 10 MHz.

■ PM6680B

- Set the counter to Default Settings by pressing **PRESET**.
- Connect EXT REF out from another counter to input A.
- Connect a 10 MHz, 200 mV rms, (0.57 V p-p) signal to EXT REF IN at the rear, terminated with 50 Ω .
- Select Ext Ref.
- The display should show 10 MHz.

EXT ARM Input

- Select AUTO OFF.
- Settings for pulse generator: single shot pulse, amplitude TTL = 0 - 2 V_{PP}, and duration = 10 ns.
- Connect a pulse generator to Ext Arm input.
- Press **START ARM** key.

- Press **SELECT** key until display shows 'POS', confirm with **ENTER** key three times.
- The counter does not measure.
- Apply one single pulse to Ext Arm input.
- The counter measures once and shows 10 MHz on the display.

TRIG LEVEL A&B Outputs

- Press the **PRESET** key, to set the timer/counter to Default Settings.
- Connect a voltmeter to TRIG LEVEL A(B) OUT at the rear.
- Set the Trigger Level (SET A/B) on the front to the following values, and verify the voltmeter’s readout:

SET A(B)	Readout		Pass	
	PM6680B	PM6681	Input A	Input B
+5.00 V	+0.5 ± 0.043 V	+5 ± 0.28 V		
-5.00 V	-0.5 ± 0.043 V	-5 ± 0.28 V		
0.00 V	0.0 ± 0.003 V	0 ± 0.030 V		

Table 9-7 Trigger level outputs check

Probe Comp View

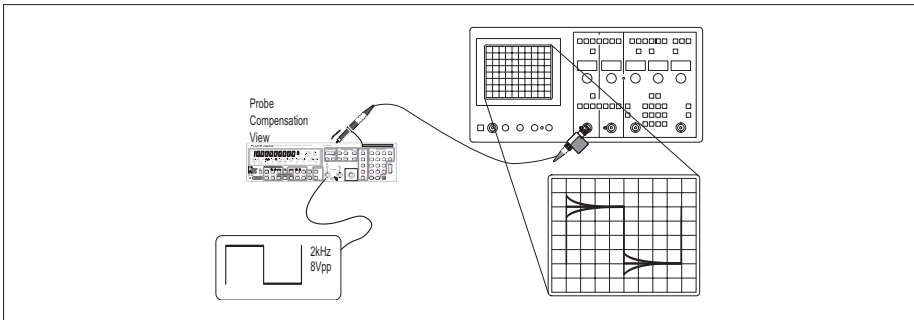

Figure 9-3 Adjustment of the counter's probe.

- Press the **PRESET** key to set the timer/counter to Default Settings.
- Select TIME A-B, AUTO OFF, X1 attenuation and DC coupling for both channels.
- Set the LF synthesizer to 2 kHz square wave and 8 V_{PP} amplitude.
- Connect synthesizer to Input A via a BNC-cable.
- Use an oscilloscope to check the signal at Probe Comp View, at the rear. The square wave will have the same step response and 4 V_{PP} amplitude.
- Select X10 attenuation.
- Check that the square wave is 2 kHz and 0.4 V_{PP}.
- Repeat this test for channel B.

Measuring Functions

Preparation for Check of Measuring Function:

- Connect a 10 MHz sine wave signal with 2.0 V_{PP} amplitude.
- Press the **PRESET** key, to set the timer/counter to Default Setting.

Select the following settings for the timer/counter:

- 50 Ω impedance for A and B
- AUTO OFF
- COM A
- Check that the timer/counter performs the correct measurement, by displaying the result as shown under the “Display” column in Table 9-8.



Selected Function	Action	Display	Pass
FREQ A		10 MHz ²⁾	
FREQ C		----- ³⁾	
PER A		100 ⁻⁹ s ²⁾	
RATIO A/B		1.0000000	
	Select NEG SLOPE B	1.0000000	
RATIO C/B		0.0000000 ³⁾	
PWIDTH A		50.000 ⁻⁹ s ¹⁾	
TIME A-B		50.000 ⁻⁹ s ¹⁾	
PHASE A-B		180 or -180 ¹⁾	
TOT A-B MAN		0	
	Deselect COM A	0	
TOT ST/STOP		counting	
TOT ST/STOP		stop counting	
	Select COM A	0	
TOT A  B			
TOT A  B			
	Select POS SLOPE B	0	
DUTY F A		0.500000 ¹⁾	
	Select AUTO	0.500000 ¹⁾	
RISE/FALL A		30.000 ⁻⁹ s ²⁾	
VOLT MAX/MIN		1.000 - 1.000 V ²⁾	

Table 9-8 Measuring functions check

- 1) Value depends on the symmetry of the signal.
- 2) Exact value depends on input signal.
- 3) If HF option is installed.

Check of HOLD OFF Function

Press **PRESET** on the timer/counter .

Select the following settings for the timer/counter:

- 50 Ω impedance for A and B.
- DC coupling for A and B.
- AUTO OFF, X1 attenuation for A and B.
- Trigger level = 0.5 V.
- Set the Hold off time to 10^{-6} s, (default in the PM6680B).

Select the following settings for the pulse generator:

- Period = 100 μ s.
- Duration 10 ns.
- Double pulse.
- Delay = 1 μ s.

– Amplitude = 1.0 V_{PP}, (high level +1V and low level 0V).

– Rise time 2 ns.

– Connect the Pulse generator Pulse Out to Input A and check the following results:

– Freq A measuring without Hold Off = 20 kHz.

– Freq A measuring with Hold Off = 10 kHz.

Connect the signal to Input B, press the **SWAP A \leftrightarrow B** key, and repeat the test for Input B.

Options

Input C Check

To verify the specification of input C in the instrument, perform the measurements below.

Connect the output of the signal generator to the HF input of the counter.

- Connect the 10 MHz REFERENCE OUT of the generator to the REFERENCE IN at the rear panel of the counter.

– Press **PRESET** on the timer/counter.

– Select FREQ C.

– Select EXT REF.

– Generate a sine wave in accordance with the tables.

Verify that the counter is counting correctly. (The last digit will be unstable)

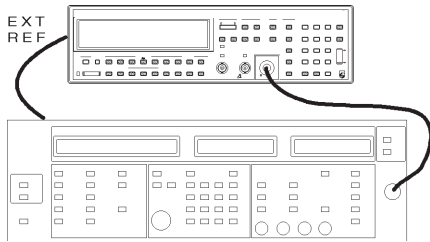

Figure 9-4 HF input test setup

Frequency MHz	Amplitude		Pass
	mV _{RMS}	dBm	
150-300	20	-21	
-2500	10	-27	
-3500	15	-23,5	
-4200	25	-19	
-4500	50	-13	

Table 9-11 Sensitivity of PM9625

Frequency MHz	Amplitude		Pass
	mV _{RMS}	dBm	
70-900	10	-23	
900-1100	15	-23	
1100-1300	40	-15	

Table 9-9 Sensitivity of PM9621

Frequency MHz	Amplitude		Pass
	mV _{RMS}	dBm	
150-300	20	-21	
-2200	10	-27	
-3500	15	-23,5	
-4200	25	-19	

Table 9-12 Sensitivity of PM9625B

Frequency MHz	Amplitude		Pass
	mV _{RMS}	dBm	
100-300	20	-21	
300-2500	10	-27	
2500-2700	20	-21	

Table 9-10 Sensitivity of PM9624

This page is intentionally left blank.

Chapter 10

Preventive Maintenance

Calibration

To maintain the performance of the timer/counter, we recommend that you calibrate the timebase of your instrument every year, or more often if you require greater timebase accuracy. Calibration should be performed with traceable references and instruments at a certified calibration laboratory. Contact your local service center for calibration.

To know the present status of your instrument, test your counter from time to time. The test can be made according to the information in Chapter 9, "Performance Check."

Oscillators

The frequency of the reference crystal oscillator is the main parameter that influences accuracy of a counter. External conditions, such as ambient temperature and supply voltage, influence the frequency, but aging is also a factor. When adjusting, you compensate the reference crystal oscillator only for deviation in frequency due to aging.

■ Some important points:

The high-stability oscillators, PM9691 and PM9692, have been built into an oven to keep the oscillator temperature as stable as possible. Continuous operation is also important for optimum stability. PM9692, for example, has an aging/24h that is 3×10^{-10} when operating continuously. After a power interruption, the oscillator drift is higher and the specification of

Model	PM6680B/ PM6681	PM6680B/ PM6681	PM6680B/ PM6681	PM6680B/ PM6681	PM6681R
Option	Standard	PM9678B	PM9691	PM9692	
Timebase type	UCXO	TCXO	OCXO	OCXO	Rubidium
Total uncertainty, for operating temperature 0°C to 50°C, @ 2σ (95 %) confidence interval:					
-1 month after calibration	$<1.2 \times 10^{-5}$	1.1×10^{-6}	$<3 \times 10^{-8}$	$<8 \times 10^{-9}$	$<4 \times 10^{-10}$
-3 months after calibration	$<1.2 \times 10^{-5}$	1.1×10^{-6}	$<4 \times 10^{-8}$	$<1.2 \times 10^{-8}$	$<4 \times 10^{-10}$
-1 year after calibration	$<1.2 \times 10^{-5}$	1.2×10^{-6}	$<1 \times 10^{-7}$	$<2.5 \times 10^{-8}$	1) $<4 \times 10^{-10}$
-2 years after calibration	$<1.5 \times 10^{-5}$	1.5×10^{-7}	$<2 \times 10^{-7}$	$<5 \times 10^{-8}$	1) $<6 \times 10^{-10}$
Typical total uncertainty, for operating temperature 20°C to 26°C, @ 2σ (95 %) confidence interval:					
-1 month after calibration	$<4 \times 10^{-6}$	3.1×10^{-7}	$<3 \times 10^{-8}$	$<7 \times 10^{-9}$	$<1 \times 10^{-10}$
-3 months after calibration	$<4 \times 10^{-6}$	4.2×10^{-7}	$<4 \times 10^{-8}$	$<1.2 \times 10^{-8}$	$<2 \times 10^{-10}$
-1 year after calibration	$<7 \times 10^{-6}$	7×10^{-7}	$<1 \times 10^{-7}$	$<2.5 \times 10^{-8}$	1) $<2.5 \times 10^{-10}$
-2 years after calibration	$<1.2 \times 10^{-5}$	1.2×10^{-6}	$<2 \times 10^{-7}$	$<5 \times 10^{-8}$	1) $<5 \times 10^{-10}$

1) After first year of operation. For first year add 3×10^{-10} to table value

For complete specifications see chapter 11 (Specifications)

3×10^{-10} per 24h is reached only after 48h of continuous operation.

- The frequency uncertainty for standard oscillators is mainly dependent on the ambient temperature. Variations in ambient temperature between 0 and 50 °C may cause a frequency change of up to 100 Hz, whereas the aging per month is only 5 Hz. When operating, there is always a temperature increase inside the counter that will influence the oscillator.

How often should you calibrate?

In the table on the preceding page you can see the uncertainty of your time base oscillator for various MTBRC (Mean Time Between Recalibration) intervals.

Compare the requirements of your application with the values in the table, and select the proper MTBRC accordingly.

Please note that the frequency uncertainty when operating in a temperature controlled environment is different from field use. See the two sections in the table.



When adjusted, keep in mind that the reference crystal oscillator will be compensated only for frequency deviation caused by aging.

Input amplifiers

This calibration adjustment sets the hysteresis compensation of the input amplifiers. It minimizes the errors in voltage, phase and other measurements where it is essential to trigger exactly at the right point of the signal.



Since the calibration compensates for the temperature drift of the input amplifiers, it should be

made at the test setup ambient temperature.

- Disconnect any signals from inputs A and B.
- Press **AUX MENU**
- Select **CR. HYST** with the **SELECT/SET** key.
- Confirm your selection by pressing **ENTER**.
- If error code 1191 is shown on the display, the calibration constants are out of range and you must do the calibration over again. This normally only occurs if you have forgotten to remove the signal leads, or at temperatures outside normal operating range.

When the input calibration procedure can be done without error codes, the calibration is correct.

If you cannot calibrate your instrument without error codes, hardware calibration is necessary. Contact your local Fluke service center.

Other Maintenance

Fan Replacement

The PM6681 is always equipped with a fan, and there is a fan option available for the PM6680B, the 9628/02. If the fan is operating in a 24h/day system, you need to replace the fan every second year to maintain high reliability. For part-time applications and low ambient temperatures, an extended service interval is acceptable.

Backup Battery Replacement

The counter has a lithium battery to power the memory that stores the setting data when the power is switched off. The lithium battery has an estimated lifetime of five to ten years.

We recommend you to replace the battery every five years to avoid loss of data in operation.

When the battery is empty, the counter will lose all settings and any data in memory. This is no big problem for the PM6680B, but the PM6681 will also lose its interpolator calibration data, indicated by the display message **CAL. LOSE** at power-up.

Contact your local Fluke service center to replace the battery or recalibrate the interpolators.

Chapter 11

Specifications

Introduction

- This chapter differs from the other chapters in this manual. The left column contains the PM6680B spec., while the right column contains the PM6681 spec. Look at the page header to see which column to read.
- Only values with tolerances or limits are guaranteed data. Values without tolerances are informative data, without guarantee.
- Refer to page 11-13 for uncertainty information.
- Inputs A and B can be swapped internally in all modes except Rise and Fall Time.

PM6680B

Measuring Functions

Frequency A, B, C

Range:

Input A: 0.01 Hz (10^{-10} Hz in SINGLE) to 225 MHz

Input B: 0.01 Hz (10^{-10} Hz in SINGLE) to 100 MHz

Input C: 70 MHz to 1.3 GHz (PM9621)
100 MHz to 2.7 GHz (PM9624)
150 MHz to 4.2 GHz (PM9625B)
150 MHz to 4.5 GHz (PM9625)

Resolution: 10 digits in 1s measuring time

PM6681

Measuring Functions

Frequency A, B, C

Range:

Input A: 0.11 Hz (10^{-10} Hz in SINGLE) to 300 MHz

Input B: 0.03 Hz (10^{-10} Hz in SINGLE) to 100 MHz

Input C: 70 MHz to 1.3 GHz (PM9621)
100 MHz to 2.7 GHz (PM9624)
150 MHz to 4.2 GHz (PM9625B)
150 MHz to 4.5 GHz (PM9625)

Resolution: 11 digits in 1s measuring time

Frequency Burst A, B

Frequency and PRF of burst signals can be measured without external control signal.

Range:

Input A: Up to 160 MHz

Input B: Up to 100 MHz

Resolution: 10 digits in 1s measuring time

Period A

Range: 6 ns to 100s (10^{10} s in SINGLE)

Resolution: 10 digits in 1s measuring time

Ratio A/B, C/B

Range: 10^{-9} to 10^{15}

Frequency Range:

Input A,B: 10^{-10} Hz to 160 MHz

Input C: Up to 1.3 GHz, 4.2 GHz, or 4.5 GHz with options

Time Interval A to B

Range: 0 ns to 10^{10} s, Typical: -2 ns to 10^{10} s (B to A, 3 ns to 10^{10} s)

Frequency Range: Up to 160 MHz

Resolution:

Single Shot: 250 ps

Frequency Burst A, B, C

Frequency and PRF of burst signals can be measured without external control signal and with selectable start delay.

Range:

Input A: Up to 300 MHz

Input B: Up to 100 MHz

Input C: Up to 3 GHz with options

Resolution: 11 digits in 1s measuring time

Start Delay Range:

200 ns to 1s, 100 ns resolution

Period A

Range: 3.3 ns to 9s (10^{10} s in SINGLE)

Resolution: 11 digits in 1s measuring time

Ratio A/B, C/B

Range: 10^{-9} to 10^{15}

Frequency Range:

Input A, B: 10^{-10} Hz to 160 MHz

Input C: Up to 1.3 GHz, 4.2 GHz, or 4.5 GHz with options

Time Interval A to B

Range: 0 ns to 10^{10} s (B to A: 5 ns to 10^{10} s)

Frequency Range: Up to 160 MHz

Resolution:

Single Shot: 50 ps (1 ps average)

Pulse Width A**Range:** 3 ns to 10^{10} s**Frequency Range:** Up to 160 MHz**Rise and Fall Time A****Range:** 3 ns to 10^{10} s**Frequency Range:** Up to 160 MHz**Input Amplitude:** >500 mVp-p**Phase A Relative B****Range:** -180° to 360° **Resolution:** 0.01°**Frequency Range:** 0.03 Hz to 160 MHz**Voltage Range:** >100 mV rms**Duty Factor A, B****Range:** 0.000001 to 1.000000**Frequency Range A:** 0.01 Hz to 160 MHz**Frequency Range B:** 0.01 Hz to 100 MHz**Totalize A, B****Range:** 0 to 10^{17}
0 to 10^{10} in A - B modes**Frequency Range:** 0 to 160 MHz**A Gated by B:**

Event counting on Input A during the presence of a pulse on Input B. Single or cumulative event counting during set measuring time.

A Start/Stop by B:**Pulse Width A****Range:** 3 ns to 10^{10} s**Frequency Range:** Up to 160 MHz**Rise and Fall Time A****Range:** 3 ns to 10^{10} s**Frequency Range:** Up to 160 MHz**Input Amplitude:** >250 mVp-p**Phase A Relative B****Range:** -180° to $+360^\circ$ **Resolution:** 0.01°**Frequency Range:** 0.03 Hz to 160 MHz**Voltage Range:** Full signal range**Duty Factor A****Range:** 0.000001 to 1.000000**Frequency Range A:** 0.11 Hz to 160 MHz**Frequency Range B:** 0.03 Hz to 100 MHz**Totalize A, B****Range:** 0 to 10^{17}
0 to 10^{10} in A - B modes**Frequency Range:** 0 to 160 MHz**A Gated by B:**

Event counting on Input A during the presence of a pulse on Input B. Single or cumulative event counting during set measuring time.

A Start/Stop by B:

Event counting on Input A between two consecutive pulses on Input B

Manual A–B:

Input A minus Input B event counting with manual start and stop

Manual/Timed A–B:

Input A minus Input B event counting with manual start. Stop after set measuring time. Time counted from first trigger event on A.

AC/DC Voltage A, B

DC Range: –50V to +50V

Sinewave Range: 100 mV p-p to
100V p-p

Frequency Range: DC, 100 Hz to
100 MHz

Mode: V max, V min, V p-p

Gated Volt:

External masking of unwanted signal components such as overshoot

Event counting on Input A between two consecutive pulses on Input B.

Manual A–B:

Input A minus Input B event counting with manual start and stop

Manual/Timed A–B:

Input A minus Input B event counting with manual start. Stop after set measuring time. Time counted from first trigger event on A.

AC/DC Voltage A, B

DC Range: –50V to +50V

Sinewave Range: 100 mV p-p to
100V p-p

Frequency Range: DC, 1 Hz (default
100 Hz) to 100 MHz

Mode: V max, V min, V p-p

Gated Volt:

External masking of unwanted signal components such as overshoot

Input Specifications

Input A and Input B

Frequency Range:

DC- Coupled: DC to 225 MHz

AC- Coupled: 10 Hz to 225 MHz

Coupling: AC or DC

Rise Time: Approx. 1.5 ns

Impedance: 1 M Ω //30 pF or 50 Ω (VSWR \leq 2:1)

Trigger Slope: Positive or negative

Channel Inputs A and B: Separate, common via A or swapped

Max. Channel Timing Difference: 1 ns

Sensitivity: 20 mV rms, < 100 MHz
30 mV rms, 100 MHz to 200 MHz
40 mV rms, > 200 MHz

Pulse Width: >5 ns at 60 mV p-p,
>3 ns at 90 mV p-p

Attenuation: 1X or 10X

Hysteresis Window (1X): 30 mV p-p

Variable Hysteresis (Frequency A (1X)): 60 mV p-p to 10 V p-p up to 120 MHz

Dynamic Range (1X): 60 mV p-p to 10 V p-p within \pm 5 V window

Trigger Level: Read-Out on display

Input Specifications

Input A and Input B

Frequency Range:

DC-Coupled: DC to 300 MHz

AC-Coupled: 10 Hz to 300 MHz

Coupling: AC or DC

Rise Time: Approx. 1 ns

Impedance: 1 M Ω //15 pF or 50 Ω (VSWR \leq 2:1)

Trigger Slope: Positive or negative

Channel Inputs A and B: Separate, common via A or swapped

Max. Channel Timing Difference: 500 ps

Sensitivity: 20 mV rms, <100 MHz
30 mV rms, 100 MHz to 200 MHz
40 mV rms, 200 MHz to 250 MHz
60 mV rms, >250 MHz

Pulse Width: >5 ns at 60 mV p-p,
>3 ns at 90 mV p-p

Attenuation: 1X or 10X

Hysteresis Window (1X): 20 mV p-p

Variable Hysteresis (all one channel Input A measurements (1X)): 30 mV p-p to 10V p-p up to 120 MHz

Dynamic Range (1X): 60 mV p-p to 10 V p-p within \pm 5 V window

Trigger Level: Read-Out on display

Range (1X): -5.1V to +5.1V

Range (10X): -51V to +51V

Resolution (1X): 20 mV

Uncertainty (1X) Separate Inputs: ±
(20 mV +1% of trigger level setting)

Uncertainty (1X) Common Input:
± (20 mV +3% of trigger level setting)

 *Multiply all values by 10 when using 10X attenuator setting.*

AUTO Trigger Level:

Trigger level is automatically set to 50% point of input signal (10% and 90% for Rise/Fall Time, 75% and 25% for variable hysteresis A)

Amplitude: >150 mV p-p

Minimum Frequency: Default 100 Hz, selectable between 100 Hz or 10 kHz to minimize dead time between measurements

Analog Low Pass Filter A:

100 kHz fixed, >40 dB attenuation at 1 MHz

Digital Low pass Filter A and B: 1 Hz to 5 MHz using trigger Hold Off

Trigger Indicator: Tri-state LED indicator

Maximum Voltage Without Damage:

1 MΩ: 350 V (DC+AC pk) at DC to 440 Hz, falling to 12 V rms (1X) and 120 V rms (10X) at 1 MHz

50Ω: 12 V rms

Input C

See option PM9621, option PM9624 and option PM9625

Range (1X): -5V to +5V

Range (10X): -50V to +50V

Resolution (1X): 1.25 mV

Uncertainty (1X) Separate Inputs: ±
(4 mV +1% of trigger level setting)

Uncertainty (1X) Common Input:
± (6 mV +1% of trigger level setting)

 *Multiply all values by 10 when using 10X attenuator setting.*

AUTO Trigger Level:

Trigger level is automatically set to 50% point of input signal (10% and 90% for Rise/Fall Time, 75% and 25% for variable hysteresis A)

Amplitude: >60 mV p-p

Minimum Frequency: Default 100 Hz, selectable between 1 Hz to 50 kHz to minimize dead time between measurements

Analog Low Pass Filter A:

100 kHz fixed. >40 dB attenuation at 1 MHz

Digital Low Pass Filter A and B: 1 Hz to 10 MHz using trigger Hold Off

Trigger Indicator: Tri-state LED indicator

Maximum Voltage Without Damage:

1 MΩ: 350V (DC + AC pk) at DC to 440 Hz, falling to 12V rms (1X) and 120V rms (10X) at 1 MHz

50Ω: 12 V rms

Input C

See option PM9621, option PM9624 and option PM9625

External Reference Input

The use of external reference is indicated on the display

Frequency: 10 MHz
(1, 2 and 5 MHz accepted if option PM9697 is installed)

Voltage Range: 500 mV rms to 10 V rms

Impedance: >1 k Ω for signals <1V rms,
500 Ω for signals >1V rms (AC coupled)

Arming Input

Most measuring functions can also be performed via Input E

Frequency Range: DC to 50 MHz

Pulse Width: >10 ns

Slew Rate: >2 V/ μ s

Trigger Level: TTL level, 1.4 V nominal

Trigger Slope: Positive or negative

Damage Level: 25V peak

Impedance: 2 k Ω (DC coupled)

External Reference Input

The use of external reference is indicated on the display

Frequency: 1 MHz, 2 MHz, 5 MHz or
10 Mhz

Voltage Range: 200 mV rms to 10V rms

Impedance: >1 k Ω for signals <1V rms,
500 Ω for signals >1V rms (AC coupled)

Arming Input

Most measuring functions can also be performed via Input E

Frequency Range: DC to 100 MHz

Pulse Width: >5 ns

Slew Rate: >2 V/ μ s

Trigger Level: TTL level, 1.4V nominal

Trigger Slope: Positive or negative

Damage Level: 25V peak

Impedance: 2 k Ω (DC coupled)

Output Specifications

Reference Output

Frequency:

10 MHz sinewave

Output Level: > 0.5 V rms into 50Ω load

Coupling: AC

Gate Open Output

Output Level:

Gate Closed: <0.4V

Gate Open: >1.4V into 50Ω load

Internal delay: 20 ns

Trigger Level Outputs

Buffered outputs for input A and B trigger levels

Output Level: $\frac{\text{Trigger Level}}{10 \times \text{Attenuator Setting}}$

Uncertainty: ± (3 mV + 8% of output level)

Output Impedance: 3 kΩ

Probe Compensation Outputs

Buffered outputs for input A and B signals. To be used for adjustment of probes to best pulse response for the combination of probe and counter input.

Output Specifications

Reference Output(s)

Frequency:

PM6681: 1 x 10 MHz sinewave

PM6681R: 6 x 10 MHz, 1 x 5 MHz sinewave

Output Level: >0.5V rms into 50Ω load

Coupling: AC

Gate Open Output

Output Level:

Gate Closed: <0.4V

Gate Open: >1.4V into 50Ω load

Internal delay: 20 ns

Trigger Level Outputs

Buffered outputs for input A and B trigger levels

Output Level: $\frac{\text{Trigger Level}}{\text{Attenuator Setting}}$

Uncertainty: ±(30 mV + 5% of output level)

Output Impedance: 100Ω

Probe Compensation Outputs

Buffered outputs for input A and B signals. To be used for adjustment of probes to best pulse response for the combination of probe and counter input.

Output Level: $\frac{\text{Input level}}{\text{Attenuator setting}}$

Test Signal: 2 kHz to 3 kHz square wave

Output Impedance: 1.5 k Ω

Analog Output:

Voltage Range:

0 to 4.98V in 20 mV steps, proportional to any consecutive 3-digits selected from the display.

Output level uncertainty:

$\pm(10 \text{ mV} + 1\% \text{ of output level})$

Output Impedance: 200 Ω

Output Level: $0.5 \times \frac{\text{Input amplitude}}{\text{Attenuator setting}}$

Test Signal: 2 kHz to 3 kHz square wave

Output Impedance: 500 Ω

Analog Output:

Voltage Range:

0 to 4.98V in 20 mV steps, proportional to any consecutive 3-digits selected from the display.

Output level uncertainty:

$\pm(10 \text{ mV} + 1\% \text{ of output level})$

Output Impedance: 200 Ω

Auxiliary Functions

Trigger Hold Off

After start of measurement, Trigger Hold Off disables stop triggering during a preset time or a preset number of trigger events on input B in Time Interval, Rise/Fall Time and Pulse Width measuring functions.

Trigger Hold Off functions as a 1 Hz to 5 MHz digital low pass filter in Frequency, Period. It filters the A signal in Ratio A/B and Phase A -B.

Time Delay Range: 200 ns to 1.6s,
100 ns resolution

Event Delay Range B: 2 to $2^{24}-1$, negative slope (max. 20 MHz)

External Arming

Arming is used to inhibit start- and/or stop triggering with the aid of an external signal.

Auxiliary Functions

Trigger Hold Off

After start of measurement, Trigger Hold Off disables stop triggering during a preset time or a preset number of trigger events on input B in Time Interval, Rise/Fall Time and Pulse Width measuring functions.

Trigger Hold Off functions as a 1 Hz to 10 MHz digital low pass filter in Frequency, Period. It filters the A signal in Ratio A/B and Phase A -B.

Time Delay Range: 60 ns to 1.34s,
10 ns resolution

Event Delay Range B: 2 to $2^{24}-1$, negative slope (max. 100 MHz)

External Arming

Arming is used to inhibit start- and/or stop triggering with the aid of an external signal.

Stop arming is not applicable to the time average functions (Time, Rise/Fall, Pulse Width), Phase and Duty Factor.

For time average functions the start arming is applied only to the first measurement in the average sequence. The arming function is not applicable to the Frequency Burst and Volt functions.

Arming Delay:

Arming can be delayed with respect to the external arming trigger event until either of the following occurs:

- Preset arming time has elapsed.
- Preset number of trigger events on B have occurred.

Time Delay Range B and E:

200 ns to 1.6s, 100 ns resolution

Event Delay Range B:

2 to $2^{24}-1$, negative slope (up to 20 MHz)

Statistics

Statistics may be applied to all measuring functions, with the exception of Manual Totalize. Volt A max/min is converted to Volt A p-p before statistics is applied. Statistics may also be applied on the result from Mathematics.

If result is frozen with HOLD, all statistical parameters for the samples can be recalled.

Max and Min:

Displays maximum and minimum values of selected sample size.

Mean and Std Dev.:

Displays calculated arithmetic mean and standard deviation of selected sample size.

Sample Size: 1 to 65535 samples.

Stop arming is not applicable to the time average functions (Time, Rise/Fall, Pulse Width), Phase and Duty Factor.

For time average functions the start arming is applied only to the first measurement in the average sequence. The arming function is not applicable to the Frequency Burst and Volt functions.

Arming Delay:

Arming can be delayed with respect to the external arming trigger event until either of the following occurs:

- Preset arming time has elapsed.
- Preset number of trigger events on B have occurred.

Time Delay Range B and E:

200 ns to 1.6s, 100 ns resolution

Event Delay Range B:

2 to $2^{24}-1$, negative slope (up to 20 MHz)

Statistics

Statistics may be applied to all measuring functions, with the exception of Manual Totalize. Volt A max/min is converted to Volt A p-p before statistics is applied. Statistics may also be applied on the result from Mathematics.

If result is frozen with HOLD, all statistical parameters for the samples can be recalled.

Max and Min:

Displays maximum and minimum values of selected sample size.

Mean and Std Dev.:

Displays calculated arithmetic mean and standard deviation of selected sample size.

Sample Size: 1 to $2 * 10^9$ samples.

Mathematics

Mathematics may be applied to all Measuring Functions. Volt A max/min is converted to Volt A p-p measuring function before mathematics is applied.

Functions:

$(K \cdot X + L)/M$ or $(K/X + L)/M$, where X is current reading and K, L, and M are selectable constants

K, L, M Constants:

Set via keyboard, as frozen reference value from display (X_0) or as value from preceding measurement (X_{n-1}).

Other Functions

Measuring-Time:

Single cycle, 800 ns, 1.6, 3.2, 6.4, 12.8 μ s, and 50 μ s to 20s (or to 400s for some functions). The effective measuring time can be extended through multiple average measurements, using the Statistics function. The short measuring times 0.8 to 12.8 μ s are only applicable to frequency and period measurements.

Hold:

Freezes measuring result until a new measurement is initiated via Restart.

Check:

Applies 10-MHz Timebase Frequency to the measuring logic.

Settings:

20 complete instrument settings can be saved and recalled from internal non-volatile memory. 10 memory positions can be user protected.

Auxiliary Menu: Gives access to additional functions.

Display:

10-digits LCD with high-luminance backlight. 2 more digits made visible via the use of mathematics. Insignificant digits can be blanked

Mathematics

Mathematics may be applied to all Measuring Functions. Volt A max/min is converted to Volt A p-p measuring function before mathematics is applied.

Functions:

$(K \cdot X + L)/M$ or $(K/X + L)/M$, where X is current reading and K, L and M are selectable constants

K, L, M Constants:

Set via keyboard, as frozen reference value from display (X_0) or as value from preceding measurement (X_{n-1}).

Other Functions

Measuring Time:

Single cycle, 80, 160, 320, 640, 1280 ns, and 20 μ s to 20s (or to 400s for some functions). The effective measuring time can be extended through multiple average measurements, using the Statistics function. The short measuring times 80 to 1280 ns are only applicable to frequency and period measurements.

Hold:

Freezes measuring result, until a new measurement is initiated via Restart.

Check:

Applies 100-MHz Timebase Frequency to the measuring logic.

Settings:

20 complete instrument settings can be saved and recalled from internal non-volatile memory. 10 memory positions can be user protected.

Auxiliary Menu: Gives access to additional functions.

Display:

10-digits LCD with high-luminance backlight. 2 more digits made visible via the use of mathematics. Insignificant digits can be blanked

Measurement Uncertainties

Time Interval, Pulse Width and Rise and Fall Time

Total Uncertainty:

Total Random Uncertainty rms:

$$\frac{\sqrt{(250\text{ps})^2 + (\text{Start Trigger Error})^2 + (\text{Stop Trigger Error})^2}}{\sqrt{N}}$$

(or minimum 100 ps)

Total Systematic Uncertainty:

- ± *Trigger Level Timing Error*
- ± *1 ns Systematic Error*
- ± *Time Base Error × Time Interval or Pulse Width or Rise and Fall Time*

LSD Displayed:

$$\frac{500\text{ps}}{\sqrt{N}}$$

Frequency and Period

Total Uncertainty:

Total Random Uncertainty rms:

$$\frac{\sqrt{(250\text{ps})^2 + 2 \times (\text{Start Trigger Error})^2}}{\text{MeasuringTime}} \times$$

× *Frequency or Period*

Total Systematic Uncertainty:

- ± *Time Base Error × Frequency or Period* ±
- ± *250ps / MeasuringTime*

Measurement Uncertainties

Time Interval, Pulse Width and Rise and Fall Time

Total Uncertainty:

Total Random Uncertainty rms:

$$\frac{\sqrt{(QE)^2 + (\text{Start Trigger Error})^2 + (\text{Stop Trigger Error})^2}}{\sqrt{N}}$$

(or minimum 1 ps)

Total Systematic Uncertainty:

- ± *Trigger Level Timing Error*
- ± *500 ps Systematic Error*
- ± *Time Base Error × Time Interval or Pulse Width or Rise and Fall Time*

LSD Displayed:

$$\frac{50\text{ps}}{\sqrt{N}}$$

Frequency and Period

Total Uncertainty:

Total Random Uncertainty rms:

$$\frac{\sqrt{(QE)^2 + 2 * (\text{Start Trigger Error})^2}}{\text{MeasuringTime}} \times$$

× *Frequency or Period*

Total Systematic Uncertainty:

- ± *Time Base Error × Frequency or Period* ±
- ± *QE / MeasuringTime*

LSD Displayed:

$$\frac{50 \text{ ps} \times \text{Frequency or Period}}{\text{Measuring Time}}$$

Ratio f_1 / f_2 **Total Uncertainty:**

Total Random Uncertainty rms

$$\frac{\sqrt{(\text{Prescaler Factor})^2 + 2 \times (f_1 \times \text{Start Trig. Error of } f_2)^2}}{f_2 \times \text{Measuring Time}}$$

LSD Displayed:

$$\frac{\text{Prescaler Factor}}{f_2 \times \text{Measuring Time}}$$

Phase**Total Uncertainty:**

Total Random Uncertainty rms:

$$\frac{\sqrt{(250 \text{ ps})^2 + (\text{Start Trig. Error})^2 + (\text{Stop Trig. Error})^2}}{\sqrt{N}} \times$$

$\times \text{Frequency} \times 360^\circ$

(or minimum $100 \text{ ps} \times \text{Frequency} \times 360^\circ$)

Total Systematic Uncertainty: For
sinewave signals >100 mV rms, and with
trigger levels 0 V (V pk in volt):

$$\pm 0.3 \times \left(\frac{\text{Attenuator setting}}{V \text{ pk of } A} + \frac{\text{Attenuator setting}}{V \text{ pk of } B} \right)^\circ$$

$$\pm 0.9 \times \left(\frac{\text{Attenuator setting}}{V \text{ pk of } A} - \frac{\text{Attenuator setting}}{V \text{ pk of } B} \right)^\circ$$

$\pm 1 \text{ ns Systematic Error} \times \text{Frequency} \times 360^\circ$

LSD Displayed: 0.01°

LSD Displayed:

$$\frac{50 \text{ ps} \times \text{Frequency or Period}}{\text{Measuring Time}}$$

Ratio f_1 / f_2 **Total Uncertainty:**

Total Random Uncertainty rms

$$\frac{\sqrt{(\text{Prescaler Factor})^2 + 2 \times (f_1 \times \text{Start Trig. Error of } f_2)^2}}{f_2 \times \text{Measuring Time}}$$

LSD Displayed:

$$\frac{\text{Prescaler Factor}}{f_2 \times \text{Measuring Time}}$$

Phase**Total Uncertainty:**

Total Random Uncertainty rms:

$$\frac{\sqrt{(\text{QE})^2 + (\text{Start Trig. Error})^2 + (\text{Stop Trig. Error})^2}}{\sqrt{N}} \times$$

$\times \text{Frequency} \times 360^\circ$

(or minimum $1 \text{ ps} * \text{Frequency} * 360^\circ$)

Total Systematic Uncertainty: For
sinewave signals with trigger levels 0V (V
pk in volt):

$$\pm 0.2 \times \left(\frac{\text{Attenuator setting}}{V \text{ pk of } A} + \frac{\text{Attenuator setting}}{V \text{ pk of } B} \right)^\circ$$

$\pm 500 \text{ ps Systematic Error} \times \text{Frequency} \times 360^\circ$

LSD Displayed: 0.01°

QE = Quantization error, see page 11-16

Duty Factor

Total Uncertainty:

Total Random Uncertainty rms:

$$\frac{\sqrt{(250 \text{ ps})^2 + (\text{Start Trig. Error})^2 + (\text{Stop Trig. Error})^2}}{\sqrt{N}} \times$$

× Frequency

(or minimum 100 ps × Frequency)

Total Systematic Uncertainty:

± (Trigger Level Timing Error

+ 1 ns Systematic Error) × Frequency

LSD Displayed: $1 \cdot 10^{-6}$

Voltage

Uncertainty for DC:

5.1V Range(1X): ± (1% of reading + 30 mV)

51V Range (10X): ± (2% of reading + 300 mV)

Uncertainty for > 10 ns Pulses (per level):

5.1V Range(1X): ± (1% of reading + 5% of V p-p + 30 mV)

51V Range(10X): ± (2% of reading + 5% of V p-p + 300 mV)

Uncertainty for sinewave (V p-p):

5.1V range: <50 MHz: ± (6% of V p-p + 30 mV)

>50 MHz: ±(25% of V p-p + 30mV)

51V range: <50 MHz: ± (10% of V p-p + 300mV)

Duty Factor

Total Uncertainty:

Total Random Uncertainty rms:

$$\frac{\sqrt{(QE)^2 + (\text{Start Trig. Error})^2 + (\text{Stop Trig. Error})^2}}{\sqrt{N}} \times$$

× Frequency

(or minimum 1 ps × Frequency)

Total Systematic Uncertainty:

± (Trigger Level Timing Error

+ 500 ps Systematic Error) × Frequency

LSD Displayed: $1 \cdot 10^{-6}$

Voltage

Uncertainty for DC:

5V Range(1X): ± (1% of reading + 4 mV)

50V Range (10X): ± (2% of reading + 40 mV)

Uncertainty for > 10 ns Pulses (per level):

5V Range(1X): ± (1% of reading + 5% of V p-p + 4 mV)

50V Range(10X): ± (2% of reading + 5% of V p-p + 40 mV)

Uncertainty for sinewave (V p-p):

5V range: <30 MHz ± (6% of V p-p + 4 mV)

>30 MHz ± (25% of V p-p + 4 mV)

50V range: <30 MHz ± (10% of V p-p + 40mV)

QE = Quantization error, see page 11-16

Definitions of Random Uncertainty Terms

Random uncertainty is due to quantization errors, internal and external noise. The random uncertainty can be reduced to $<1 \times 10^{-10}$ or <100 ps as residual time uncertainty, by increasing the measuring time.

N (Number of samples):

Frequency <2 kHz: Measuring Time *
Freq/2.

Frequency >2 kHz: Measuring Time *
1 000

Prescaler Factor:

Input A, B:	1
Input C, PM9621	256
Input C, PM9624	16
Input C, PM9625	32

Trigger Error

Trigger error is an input signal dependent random uncertainty caused by external and/or internal noise, thereby resulting in too early or too late start- and stop-triggering. Start/Stop trigger errors:

Definitions of Random Uncertainty Terms

Random uncertainty is due to quantization errors, internal and external noise. The random uncertainty can be reduced to $<2.5 \times 10^{-12}$ or <1 ps as residual time uncertainty, by increasing the measuring time.

QE (Quantization Errors):

10°C to 40°C: 50 ps rms

0°C to 10°C, 40°C to 50°C: 75 ps rms

N (Number of samples):

Frequency <12 kHz: Meas. Time *
Freq/2.

Frequency >12 kHz: Measuring Time *
6 000

Prescaler Factor:

Input A, B:	1
Input C, PM9621	512
Input C, PM9624	32
Input C, PM9625	64

Trigger Error

Trigger error is an input signal dependent random uncertainty caused by external and/or internal noise, thereby resulting in too early or too late start- and stop-triggering. Start/Stop trigger errors:

$$\frac{\sqrt{(V_{\text{noise-input}})^2 + (V_{\text{noise-signal}})^2}}{\text{Signal slew rate } (V_s) \text{ at trigger point}} \text{ rms}$$

Vnoise-input: 200 μV rms typical

Vnoise-signal: The rms noise of the input signal over a 225 MHz bandwidth.

Definitions of Systematic Uncertainty Terms

Systematic uncertainties can be measured and compensated for by inserting external delays or using internal math functions to provide nulling.

Trigger Level Timing Error

This timing error is due to trigger level setting error, input amplifier hysteresis and input signal slew rate, and causes start- and stop- trigger level timing error.

Time Interval, Pulse Width, Rise and Fall Time, Duty Factor (1X):

$$\pm \frac{20 \text{ mV} + 1\% \text{ of set trigger level } (V)}{\text{Slewrates } (V_s) \text{ at start trigger point}}$$

$$\pm \frac{20 \text{ mV} + 1\% \text{ of set trigger level } (V)}{\text{Slew rate } (V_s) \text{ at stop trigger point}}$$

$$\pm \left(\begin{array}{c} \frac{15 \text{ mV}}{\text{Slewrates } (V_s) \text{ at start trigger point}} \\ - \\ \frac{15 \text{ mV}}{\text{Slew rate } (V_s) \text{ at stop trigger point}} \end{array} \right)$$

$$\frac{\sqrt{(V_{\text{noise-input}})^2 + (V_{\text{noise-signal}})^2}}{\text{Signal slew rate } (V_s) \text{ at trigger point}} \text{ rms}$$

Vnoise-input: 100 μV rms typical

Vnoise-signal: The rms noise of the input signal over a 300 MHz bandwidth.

Definitions of Systematic Uncertainty Terms

Systematic uncertainties can be measured and compensated for by inserting external delays or using internal math functions to provide nulling.

Trigger Level Timing Error

This timing error is due to trigger level setting error, input amplifier hysteresis and input signal slew rate, and causes start- and stop- trigger level timing error.

Time Interval, Rise and Fall Time (1X):

$$\pm \frac{4 \text{ mV} + 1\% \text{ of set trigger level } (V)}{\text{Slewrates } (V_s) \text{ at start trigger point}}$$

$$\pm \frac{4 \text{ mV} + 1\% \text{ of set trigger level } (V)}{\text{Slew rate } (V_s) \text{ at stop trigger point}}$$

Pulse Width, Duty Factor (1X):

$$\pm \frac{4 \text{ mV} + 1\% \text{ of set trigger level } (V)}{\text{Slewrates } (V_s) \text{ at start trigger point}}$$

$$\pm \frac{4 \text{ mV} + 1\% \text{ of set trigger level } (V)}{\text{Slew rate } (V_s) \text{ at stop trigger point}}$$

1 ns Systematic Error:

The 1 ns Systematic Error is due to inter-channel asymmetry and varies with the selection of measuring mode and input trigger settings. Typical error is <500 ps, (identical input signal, trigger level and slope in Time Interval A to B).

Timebase Error:

See Timebase specifications on page 10-3 for frequency deviation due to aging and temperature dependency. Error due to line voltage fluctuation is negligible.

Multiply the relative time base errors ($\frac{\Delta f}{f}$) by the measurement result to yield the absolute error for that measurement.

LSD Displayed

Unit value of Least-Significant Digit (LSD) displayed. After calculation, the LSD values are rounded to the nearest decade before display (for example ≥ 0.5 Hz will be 1 Hz and < 0.5 Hz will be 0.1 Hz). Measuring times >1 s can give significance in >10 digits.

The 11th and 12th digits can be displayed by subtracting the two most significant digits using mathematics.

Up to 12 digits mantissa is available over the GPIB interface. LSD blanking is available to reduce displayed resolution.

$$\pm \left(\frac{10mV}{\text{Slewwrate } (v/s) \text{ at start trigger point}} - \frac{10mV}{\text{Slewwrate } (v/s) \text{ at stop trigger point}} \right)$$

500 ps Systematic Error:

The 500 ps Systematic Error is due to inter-channel asymmetry and varies with the selection of measuring mode and input trigger settings. Typical error is <300 ps, (identical input signal, trigger level and slope in Time Interval A to B).

Timebase Error:

See Timebase specifications on page 10-3 for frequency deviation due to aging and temperature dependency. Error due to line voltage fluctuation is negligible.

Multiply the relative time base errors ($\frac{\Delta f}{f}$) by the measurement result to yield the absolute error for that measurement.

LSD Displayed

Unit value of Least-Significant Digit (LSD) displayed. After calculation, the indicated LSD values are rounded to the nearest decade before display (for example ≥ 0.5 Hz will be 1 Hz and < 0.5 Hz will be 0.1 Hz). Measuring times >0.1 s can give significance in >10 digits.

The 11th and 12th digits can be displayed by subtracting the two most significant digits using mathematics.

Up to 12 digits mantissa is available over the GPIB interface. LSD blanking is available to reduce displayed resolution.

General Specifications

Environmental Data

MIL-T-28000E for Type III, Class 3, Style D.

Temperature:

Operating: 0°C to +55°C

Fan Option PM9628 is required when:

- Ambient temperature >50°C or
- Internal rack temperature >45°C; while mounted with no free air convection space and when oven oscillator PM9690 or PM9691 is installed

Storage: –40°C to +70°C

Humidity: 95% RH, 0°C to 30°C

Altitude:

Operating: Up to 4600m (15 000 ft)

Non-operating: Up to 12 000m (40 000 ft)

Vibration: 3G at 55 Hz per MIL-T-28800D

Shock: Half-sine 40G per MIL-T-28800D.
Bench handling. Shipping container.

Reliability: MTBF 30 000 h (calculated)

Safety: EN 61010, CAN/CSA-C22.2 No. 1010.1-92

EMC: EN 55011 Group 1 Class B, EN 50082-1, FCC Part 15J Class A

General Specifications

Environmental Data

MIL-T-28000E for Type III, Class 3, Style D.

Temperature:

Operating: 0°C to +50°C

Fan is standard

Storage: –40°C to +70°C

Humidity: 95% RH, 0°C to 30°C

Altitude:

Operating: Up to 4600m (15 000 ft)

Non-operating: Up to 12 000m (40 000 ft)

Vibration: 3G at 55 Hz per MIL-T-28800D

Shock: Half-sine 40G per MIL-T-28800D.
Bench handling. Shipping container.

Reliability: MTBF 30 000 h (calculated)

Safety: EN 61010, CAN/CSA-C22.2 No. 1010.1-92

EMC: EN 55011 Group 1 Class B, EN 50082-1, FCC Part 15J Class A

Power Requirements

90 V rms to 265 V rms, 45 to 440 Hz, <30W

Dimensions and Weight

Width: 315 mm (12.4 in),
Height: 86 mm (3.4 in),
Depth: 395 mm (15.6 in)
Weight: Net 4 kg (8.5 lb),
Shipping 7 kg (15 lb).

Power Requirements

PM6681: 90V rms to 265V rms, 45 Hz to
440 Hz, <35W

PM6681R: 90V rms to 265V rms, 45 Hz to
440 Hz,
<100 W during warm-up (5 min)
<47 W during normal operation

Dimensions and Weight

Width: 315 mm (12.4 in),
Height: 86 mm (3.4 in),
Depth: 395 mm (15.6 in)
Weight PM6681: Net 4 kg (8.5 lb),
Shipping 7 kg (15 lb)
Weight PM6681R: Net 4.8 kg (10.5 lb),
Shipping 7.8 kg (16.8 lb)

GPIB Interface

(Option PM9626)

Programmable Functions: All front panel accessible functions including AUX MENU

Compatibility: IEEE 488.2-1987, SCPI 1991.0

Interface Functions: SH1, AH1, T6, L4, SR1, RL1, DC1, DT1, E2

Measurement Rate*):

Measure/Store Internally: Up to 2k readings/s (250 ps resolution)

Internal Memory Size: Up to 2600 readings

Trigger/Measure/Transfer: Up to 125 readings/s

Program /Measure/Transfer: Up to 30 readings/s

Data Output Format: ASCII, IEEE double precision floating point

Timeout: 100 ms to 25.5s in 100 ms steps, or off

*) Depending on measurement function and internal data format.

GPIB Interface

(Standard)

Programmable Functions: All front panel accessible functions including AUX MENU

Compatibility: IEEE 488.2-1987, SCPI 1991.0

Interface Functions: SH1, AH1, T6, L4, SR1, RL1, DC1, DT1, E2

Time Stamping: 125 ns resolution

Measurement Rate*):

Measure/Store Internally: Up to 8k readings/s (50 ps resolution)
Up to 20k readings/s (80 ns resolution)

Continuous Single-Period: Up to 40k readings/s (200 ns resolution)

Internal Memory Size: Up to 6100 readings

Trigger/Measure/Transfer: Up to 250 readings/s

Program /Measure/Transfer: Up to 125 readings/s

Data Output Format: ASCII, IEEE double precision floating point

Timeout: 64 ms to 400s in 64 ms steps, or off

*) Depending on measurement function and internal data format.

TimeView

TimeView is a software package that performs time & frequency analysis on an IBM PC/AT or compatible with VGA/EGA monitor.

Data Capture Modes and Measurement Rate*

Free-Running Measurement: 8k readings/s

Repetitive Sampling: Up to 10 MSa/s

Back-to-Back Period: Up to 40k readings/s

Waveform Capture: Yes (vertical sampling)

Instrument Control: All front panel functions and some AUX MENU functions

Data Analysis Features

- Measurement data vs time
- FFT Graph
- Root Allan Variance
- Smoothing function
- Zoom function
- Cursor measurements
- Distribution Histogram
- Setup and Measurement Data
- Archive and Printing

*Depending on measurement function and internal data format

TimeView

TimeView is a software package that performs time & frequency analysis on an IBM PC/AT or compatible with VGA/EGA monitor.

Data Capture Modes and Measurement Rate*

Free-Running Measurement: 8k readings/s

Repetitive Sampling: Up to 10 MSa/s

Back-to-Back Period: Up to 40k readings/s

Waveform Capture: Yes (vertical sampling)

Instrument Control: All front panel functions and some AUX MENU functions

Data Analysis Features

- Measurement data vs time
- FFT Graph
- Root Allan Variance
- Smoothing function
- Zoom function
- Cursor measurements
- Distribution Histogram
- Setup and Measurement Data
- Archive and Printing

*Depending on measurement function and internal data format

RF Input Options

(PM9621)

Frequency Range: 70 MHz to 1.3 GHz

Prescaler Factor: 256

Operating Input Voltage Range:

70 to 900 Mhz: 10 mVrms to 12Vrms

900 to 1100 Mhz: 15m Vrms to 12Vrms

1100 to 1300 Mhz: 40m rms to 12Vrms

Amplitude Modulation:

dc to 0.1 MHz: Up to 94% depth

0.1 to 6 MHz: Up to 85% depth

Minimum signal must exceed minimum operating input voltage.

Impedance: 50Ω nominal

Coupling: AC coupled

VSWR: <2:1

Max Voltage Without Damage:
12V rms, pin-diode protected

Connector: BNC

(PM9624)

Frequency Range: 100 MHz to 2.7 GHz

Prescaler Factor: 16

Operating Input Voltage Range:

100 to 300 MHz 20 mV rms to 12 V rms

0.3 to 2.5 GHz: 10 mV rms to 12 V rms

2.5 to 2.7 GHz 20 mV rms to 12 V rms

RF Input Options

(PM9621)

Frequency Range: 70 MHz to 1.3 GHz

Prescaler Factor: 256

Operating Input Voltage Range:

70 to 900 Mhz: 10 mVrms to 12Vrms

900 to 1100 Mhz: 15m Vrms to 12Vrms

1100 to 1300 Mhz: 40m rms to 12Vrms

Amplitude Modulation:

dc to 0.1 MHz: Up to 94% depth

0.1 to 6 MHz: Up to 85% depth

Minimum signal must exceed minimum operating input voltage.

Impedance: 50Ω nominal

Coupling: AC coupled

VSWR: <2:1

Max Voltage Without Damage:
12V rms, pin-diode protected

Connector: BNC

(PM9624)

Frequency Range: 100 MHz to 2.7 GHz

Prescaler Factor: 32

Operating Input Voltage Range:

100 to 300 MHz 20 mV rms to 12 V rms

0.3 to 2.5 GHz: 10 mV rms to 12 V rms

2.5 to 2.7 GHz 20 mV rms to 12 V rms

Amplitude Modulation: As in PM9621
Impedance: 50 Ω nominal
VSWR: < 2.5:1
Max Voltage Without Damage:
 12 V rms during max 60 s,
 pin-diode protected
Connector: Type N Female

(PM 9625)

Frequency Range: 150 MHz to 4.5 GHz
Burst frequency Range:
 150 MHz to 4.5 GHz
Prescaler Factor: 32

Operating Input Voltage Range:

150 to 300 MHz: 20 mV rms to 1V rms
 (-21 to +13 dBm)
0.3 to 2.5 GHz: 10 mV rms to 1V rms
 (-27 to +13 dBm)
2.5 to 3.5 GHz: 15 mV rms to 1V rms
 (-23.5 to +13 dBm)
3.5 to 4.2 GHz: 25 mV rms to 1V rms
 (-19 to +13 dBm)
4.2 to 4.5 GHz: 50 mV rms to 1V rms
 (-13 to +13 dBm)

Amplitude Modulation: As PM9621
Impedance: 50 Ω nominal
Coupling: AC coupled
VSWR: <2.5:1

Max Voltage Without Damage:
 12V rms (+34 dBm), pin-diode protected

Connector: Type N Female

Amplitude Modulation: As in PM9621
Impedance: 50 Ω nominal
VSWR: < 2.5:1
Max Voltage Without Damage:
 12 V rms during max 60 s,
 pin-diode protected
Connector: Type N Female

(PM 9625)

Frequency Range: 150 MHz to 4.5 GHz
Burst frequency Range:
 150 MHz to 4.5 GHz
Prescaler Factor: 32

Operating Input Voltage Range:

150 to 300 MHz: 20 mV rms to 1V rms
 (-21 to +13 dBm)
0.3 to 2.5 GHz: 10 mV rms to 1V rms
 (-27 to +13 dBm)
2.5 to 3.5 GHz: 15 mV rms to 1V rms
 (-23.5 to +13 dBm)
3.5 to 4.2 GHz: 25 mV rms to 1V rms
 (-19 to +13 dBm)
4.2 to 4.5 GHz: 50 mV rms to 1V rms
 (-13 to +13 dBm)

Amplitude Modulation: As PM9621
Impedance: 50 Ω nominal
Coupling: AC coupled
VSWR: <2.5:1

Max Voltage Without Damage:
 12V rms (+34 dBm), pin-diode protected

Connector: Type N Female

(PM 9625B)**Frequency Range:** 150 MHz to 4.2 GHz**Operating Input Voltage Range:***150 to 300 MHz:* 20 mV rms to 1V rms
(-21 to +13 dBm)*0.3 to 2.2 GHz:* 10 mV rms to 1V rms
(-27 to +13 dBm)*2.5 to 3.5 GHz:* 15 mV rms to 1V rms
(-23.5 to +13 dBm)*3.5 to 4.2 GHz:* 25 mV rms to 1V rms
(-19 to +13 dBm)

All other parameters as PM9625

(PM 9625B)**Frequency Range:** 150 MHz to 4.2 GHz**Operating Input Voltage Range:***150 to 300 MHz:* 20 mV rms to 1V rms
(-21 to +13 dBm)*0.3 to 2.2 GHz:* 10 mV rms to 1V rms
(-27 to +13 dBm)*2.5 to 3.5 GHz:* 15 mV rms to 1V rms
(-23.5 to +13 dBm)*3.5 to 4.2 GHz:* 25 mV rms to 1V rms
(-19 to +13 dBm)

All other parameters as PM9625

Timebase Options

Product family	PM6680B/PM6681/PM6681R				
Model	PM6680B/ PM6681	PM6680B/ PM6681	PM6680B/ PM6681	PM6681R	
Option	Standard	PM9691	PM9692		PM9678
Timebase type	UCXO	OCXO	OCXO	Rubidium	TCXO
Uncertainty due to: -Calibration adjustment tolerance @ +23°C ± 3°C	<1x10 ⁻⁶	<2x10 ⁻⁸	<5x10 ⁻⁹	<5x10 ⁻¹¹	<2x10 ⁻⁷
-Aging per 24 h per month per year	n.a. <5x10 ⁻⁷ <5x10 ⁻⁶	1) <5x10 ⁻¹⁰ <1x10 ⁻⁸ <7.5x10 ⁻⁸	1) <3x10 ⁻¹⁰ <3x10 ⁻⁹ <2x10 ⁻⁸	not specified 2) <5x10 ⁻¹¹ 3) <2x10 ⁻¹⁰	n.a. <1x10 ⁻⁷ <5x10 ⁻⁷
-Temperature variation: 0°C - 50°C 20°C - 26°C (typ. values)	<1x10 ⁻⁵ <3x10 ⁻⁶	<5x10 ⁻⁹ <6x10 ⁻¹⁰	<2.5x10 ⁻⁹ <4x10 ⁻¹⁰	<3x10 ⁻¹⁰ <2x10 ⁻¹¹	<1x10 ⁻⁶ <2x10 ⁻⁷
-Power voltage variation: ±10%	<1x10 ⁻⁸	<5x10 ⁻¹⁰	<5x10 ⁻¹⁰	<1x10 ⁻¹¹	<1x10 ⁻⁹
Short term stability: (Root Allan Variance) τ = 1 s τ = 10 s τ = 100 s	not specified	1x10 ⁻¹¹ 3x10 ⁻¹² 1x10 ⁻¹²	1x10 ⁻¹¹ 3x10 ⁻¹² 1x10 ⁻¹²	5x10 ⁻¹¹ 1.5x10 ⁻¹¹ 5x10 ⁻¹²	not specified
Power-on stability: -Deviation versus final value after 24 h on time, after a warm-up time of:	not specified 30 min	<1x10 ⁻⁸ 10 min	<5x10 ⁻⁹ 10 min	<4x10 ⁻¹⁰ 10 min	n.a. 30 min
Time to lock @ 25°C (PM6681R only)	n.a.	n.a.	n.a.	approx. 5 min	n.a.
Total uncertainty, for operating temperature 0°C to 50°C, @ 2σ (95 %) confidence interval: -1 year after calibration -2 years after calibration	<1.2x10 ⁻⁵ <1.5x10 ⁻⁵	<1x10 ⁻⁷ <2x10 ⁻⁷	<2.5x10 ⁻⁸ <5x10 ⁻⁸	3) <4x10 ⁻¹⁰ <6x10 ⁻¹⁰	<1.2x10 ⁻⁶ <1.5x10 ⁻⁶
Typical total uncertainty, for op- erating temperature 20°C to 26°C, @ 2σ (95 %) confidence interval: -1 year after calibration -2 years after calibration	<7x10 ⁻⁶ <1.2x10 ⁻⁵	<1x10 ⁻⁷ <2x10 ⁻⁷	<2.5x10 ⁻⁸ <5x10 ⁻⁸	3) <2.5x10 ⁻¹⁰ <5x10 ⁻¹⁰	<7x10 ⁻⁷ 1.2x10 ⁻⁶

See explanations overleaf.

Explanations

(See specifications overleaf)

- 1) after 48 hours of continuous operation
- 2) after 1 month of continuous operation
- 3) after 1st year, aging during 1st year:
 $<5 \times 10^{-10}$

UCXO: Un-Compensated X-tal Oscillator

OCXO: Oven Controlled X-tal Oscillator

Calibration adjustment tolerance

The maximal tolerated deviation from the true 10 MHz frequency after calibration. When the reference frequency does not exceed the tolerance limits at the moment of calibration, an adjustment is not needed.

Ordering Information

Basic Model

PM6680B: Basic 250 ps / 225 MHz
Timer/Counter incl. Standard Timebase,
 5×10^{-7} /month

RF Input Options *)

PM9621	1.3 GHz Input C, for PM6680B
PM9624	2.7 GHz Input C, for PM6680B
PM9625B	4.2 GHz Input C, for PM6680B
PM9625	4.5 GHz Input C, for PM6680B

Timebase Options *)

PM9678B	TCXO Timebase
PM9691	Ovenized Timebase, 1×10^{-8} /month
PM9692	Ovenized Timebase, 3×10^{-9} /month

Optional accessories

PM9611/80	Rear panel inputs
PM9622	Rack-Mount Kit
PM9626/00	GPIB-interface incl. Analog Output
PM9627	Carrying Case

Ordering Information

Basic Models

PM6681: Basic 50 ps / 300 MHz
Timer/Counter/Analyzer incl. Standard
Timebase 5×10^{-7} /month, frequency multiplier
for several external reference frequencies (1,
2, 5 or 10 MHz), GPIB interface and
Time&Frequency analysis software (TimeView)

PM6681R:

PM6681 + Rubidium Atomic Reference,
 5×10^{-11} /month

RF Input Options *)

PM9621	1.3 GHz Input C, for PM6681/PM6681R
PM9624	2.7 GHz Input C, for PM6681/PM6681R
PM9625B	4.2 GHz Input C, for PM6681/PM6681R
PM9625	4.5 GHz Input C, for PM6681/PM6681R

Timebase Options *)

PM9678B	TCXO Timebase
PM9691	Ovenized Timebase, 1×10^{-8} /month
PM9692	Ovenized Timebase, 3×10^{-9} /month

Optional accessories

PM9611/80	Rear panel inputs
PM9622	Rack-Mount Kit
PM9627	Carrying Case
PM9627H	Heavy Duty Carrying Case

PM9627H Heavy Duty Carrying Case

PM9628 Fan Option

PM9697 External Reference Frequency
Multiplier (1 or 5 MHz). Can only be installed
together with the Standard Timebase.

*) These options are factory installed and must
be ordered together with the PM6680B. They
cannot be customer retrofitted.

Manuals

4822 872 20079

User's Handbook
PM6680B/PM6681/PM6681R
Operation and Performance

4822 872 20081

User's Handbook PM6680B/PM6681/PM6685
Programming

*) These options are factory installed and must
be ordered together with the PM6681/
PM6681R. They cannot be customer retrofitted.

Manuals

4822 872 20079

User's Handbook
PM6680B/PM6681/PM6681R
Operation and Performance

4822 872 20081

User's Handbook PM6680B/PM6681/PM6685
Programming

This page is intentionally left blank.

Chapter 12

Appendix

Appendix 1, Error Messages

If the counter detects an internal error or an invalid setting, it shows an error message on the display. This appendix lists all possible error messages.

If a GPIB is installed in the counter, GPIB error messages can be displayed in addition to the messages shown below. When a GPIB error is placed in the GPIB error queue, the display shows an error code number which is explained in Chapter 7 of the Programming Manual. This error message is removed the next time the counter uses the display for a message or a measuring result.

Messages due to False Settings:

Err. Att 10

Attenuator should be in 10X position: The trigger level input range is limited between -5.1 and $+5.1V$ if attenuator is in 1X position. This means that with the attenuator set to 1X, entering 10V will give Error Att 10.

Err. Chan

Channel: An illegal channel entry for the measurement function in Auxiliary Codes Menu

Err. Fail

Failure: The internal instrument setting is not valid.

Err. no SAV

No Save: An attempt to recall a memory that has never been saved

Err. OFLO

Overflow: A math operation in the counter caused an overflow error.

Err. PrESC

Prescaler: An attempt to use the prescaler functions without a prescaler.

Err. RANGE

Range: An attempt to enter a value above the maximum or below the minimum limit was made.

Err. UFLO

Underflow: A math operation in the counter caused an underflow error.

no BUS

No Bus: No GPIB interface is installed. Displayed if the GPIB board has been removed from the PM6680B.

no DATA

No data: An attempt to read statistics data is made before data is captured.

no PrESC

No Prescaler: No Prescaler is installed.

no SIGNAL

No signal: Displayed when measurement is interrupted by a timeout. Disable Timeout (in Auxiliary Menu) or set a longer time.

Err. Prot

Protected: An attempt to make a save in a protected memory position.

OFLO

Overflow: The measurement has been abandoned due to an overflow condition.

Messages due to Severe Errors:

Err. ASIC

ASIC: Displayed when a Measuring Logic Circuits failure has been detected.

E. rR 12d6

Error RAM XXXXh: Displayed in case of a RAM test failure. XXXXh is the hexadecimal address where failure is detected first.

Err. r0

ROM: Displayed in case of a ROM test failure.

Err. UPr0E

Microprocessor: Displayed when an error is detected in the microprocessor's internal RAM, timers, or I/O port.

≡CAL. LOST≡

Calibration data lost: Press any key to get default calibration constants. No bus command can be used to bypass this message, you must use the front panel.

Probable cause for this message is that the internal backup battery is discharged. Contact your local Service Center for recalibration.

■ **Power on self test error numbers in the PM6681/PM6681R**

Contact Service Center for repair.

Processor ram error	100
Processor timer error	200
Prom checksum error	300
Display driver error	40x
Ram error	60x
Asic error	7xx
Asic measurement failed to stop	700
Asic holdoff meas: word2>0	701
Asic holdoff meas: word1 bad	702
Asic meas failed to stop (min t)	703
Asic x and y chains not same	704
Asic ipol not ready after init	710
Asic ipol not fin (single per)	711
Asic ipol not fin (min meas t)	712
Asic ipol value out of bounds	713
Asic 502 register did not clear	720
Asic 502 start w/o trig	721
Asic 502 bad holdoff meas	722
Asic 504 register did not clear	740
Asic 504 bad measurement count	741

This page is intentionally left blank.

Chapter 13

Index

Index

A

- About TimeView 8-38
 - AC/DC coupling 3-6
 - Accuracy of the FFT 8-34
 - Activate the menu bar 8-9
 - Address
 - Reading the GPIBAddress. 7-5
 - Adjustments
 - timebase 10-2
 - Air flow 1-11
 - Aliasing 8-31
 - AM modulated signals 4-10
 - Analog output 11-20
 - switching on via aux-code 7-14
 - using 7-9
 - Aperture
 - SEE Measuring time
 - Applications 8-2
 - Arming 8-19,8-24
 - delay 5-4,7-8
 - description 5-9
 - examples 5-14 - 5-28
 - indication 2-10
 - Input (E) 2-5
 - manually 5-9
 - setup time 5-13
 - specification 11-9
 - start 7-8
 - stop 7-8
 - sync. delay 5-11
 - Arming delay mode 8-20
 - Arming input 8-20
 - Arming slope 8-20
 - Attenuation 2-4,8-18
 - Attenuator
 - used to reduce noise 3-9
 - Auto 8-9,8-18
 - timeout 4-11
 - Auto Low 3-3
 - Auto once 3-4
 - Auto Scale 8-12
 - Auto trigger 3-9,4-16,6-5
 - Converting Auto levels to Manual 3-4
 - High-speed voltage mode 7-14
 - how to use 3-9
 - on only one input 7-15
 - time to determine levels 3-3
 - Auto-calibration 7-14
 - Aux
 - annunciator 7-2
 - codes 7-12
 - indication 2-10
 - menu description 7-2 - 7-16
 - Sample size for statistics 6-5
 - Average 6-2
 - mode 7-14
 - Averaging 4-12,6-2,8-17
- ## B
- Backup copy 8-3
 - Battery
 - replacement of backup 10-4
 - safety when handling 1-7
 - Bin size 8-29
 - Bin unit 8-29
 - Bins 8-28
 - Blank digits 5-5,7-7
 - Block Delay Time 8-23
 - Burst
 - Frequency (CW) 4-5,7-5
 - indication 2-10
 - PRF 4-7
 - Bursts 8-26

- C**
- Calibration 10-2 - 10-3
 - intervals 10-2
 - Capture 8-23 - 8-27
 - Capture Free-running measurement 8-15
 - Capture Free-running menu . . 8-15,8-23
 - Capture Repetitive sampling data . . 8-15
 - Capture Repetitive sampling data menu 8-15
 - Capture Repetitive sampling menu 8-25
 - Carrier frequency 8-30
 - Carrier wave frequency AM 4-10
 - Carrier wave frequency FM 4-8
 - Caution statements 1-7
 - CEC interface 8-5
 - Change the exponent 8-9
 - Channel
 - SEE Input
 - Channel B measurements 8-16
 - Common via A 8-19
 - Confidence Limits 6-7
 - CONFIG.SYS 8-5
 - Configuration file 8-4
 - Configuring TimeView 8-6 - 8-7
 - Constants 6-3
 - Cooling 1-11
 - Count error, +-1 cycle 4-11
 - Counter Setting menu 8-15 - 8-16
 - Counting
 - reciprocal 4-11
 - Coupling 8-18
 - Crystal oscillators
 - calibration 10-2
 - Cursor data area 8-8 - 8-9
 - Cursor movements 8-9 - 8-10
 - Cursors 8-31
 - CW
 - AM 4-10
 - burst 7-5
- D**
- DATA ENTRY keys 2-3
 - Data files 8-37
 - Data range 8-28
 - DC coupling 3-6
 - Default counter setting 8-22
 - Delay
 - arming sync. 5-11
 - Delayed timebase 5-4
 - Detecting modulation 8-30
 - Digit blanking 5-5 - 5-12,7-7
 - Digital Low-pass Filter 3-6
 - Dimensions 11-19
 - Display
 - hold key 2-7
 - offset with MATH 5-5
 - Display hold. 5-3,5-9
 - Display time 5-2,5-6
 - Distortion 3-10
 - Distribution histogram 8-28
 - Documentation 8-2
 - DOS 5 8-6
 - DOS Shell 8-39
 - Dot matrix printers 8-7
 - Drift 6-6,8-28
 - SEE ALSO Long time instability
 - Drift measurements 5-26
 - Duty cycle
 - SEE Duty factor
 - Duty Factor
 - uncertainty 11-14
- E**
- Earthing
 - SEE Grounding
 - EMM386 8-6
 - End of a measurement 5-6
 - END-key 8-9
 - Erroneous counts 3-9
 - Error
 - Messages 12-2
 - Error ASIC 12-2
 - Error Failure 12-2
 - Error NO TRIG 4-12
 - Error Prescaler 12-2
 - Error Protect 12-2
 - Error RAM XXXXh 12-3
 - Error Range 12-2
 - Error ROM 12-3
 - Event count 8-20
 - Event counting mode 7-14
 - Examples
 - arming 5-14 - 5-28
 - Exit 8-39

- Expanded Memory manager 8-6
- Exponent
 - indication 2-9
 - setting 2-3
- EXT ARM
 - SEE External Arming
- Ext Ref
 - key 2-4
- External arming 8-19
 - Input test 9-13
- External gate 5-9
- External Reference
 - Checking 9-13

- F**
- F1 8-14
- Fall-time
 - uncertainty 11-12
- Fan
 - replacement 10-4
- Fast Fourier transform 8-30 - 8-35
- Fast variations in the signal 8-17
- Features 8-2
- FFT 8-15
- FFT menu 8-15
- FFT menu 8-30
- FFT size 8-31
- Fields containing strings 8-9
- File format 8-37
- Filter 8-18
 - analog 3-5
 - digital 3-5
- Filter on/off 2-4
- Finding Modulations 8-17
- Firmware release
 - SEE Program version
- Fixed
 - timeout 4-11
- Fixed triggerlevels 3-4
- FM signals 4-8
- FM-modulated signals 8-28
- Fold-down Support 1-12
- Formula 11-10
- Free-running 8-34
 - measurements 5-6,5-26
- Free-running measurement 8-23
- Freeze display 2-7
- Freezing the display
 - SEE Display hold
- Frequency 4-3 - 4-13
 - burst 7-5
 - Range test 9-7
 - ratio 4-4
 - uncertainty 11-12
- Frequency deviation 8-30
- Frequency Range 11-5
- Frequency versus time
 - SEE Profiling
- Function 2-3
 - period 4-4
 - ratio 4-4
 - selection 2-3
- Functions hidden
 - SEE Aux menu
- Fuse 1-10

- G**
- Gate
 - indicator 2-7,5-3
 - output specification 11-8
- Gate Open
 - Checking 9-12
- Gated voltage measurements 4-29,7-14
- Go-detector 5-25
- GPIB
 - reading the address 7-5
- GPIB controller Timeout 8-6
- GPIB interface card
 - Installation 8-5
- GPIB.COM 8-5
- Graph area 8-8 - 8-9
- Graph cursors 8-9
- Comment 8-11,8-15
- Gray text 8-9
- Grounding 1-10

- H**
- Handle 1-12
- Hang-up 8-6
- Hardcopy 8-39
- Hardware installation 8-5
- Harmonic distortion 3-10
- Help 8-15
- Help 8-14

- HF input
 Checking 9-16
 Hidden functions
 SEE Aux menu
 Hiding digits
 SEE Digit blanking
 High measuring speed 5-7
 Histogram 8-28
 Histogram and Statistics 8-15
 Histogram and Statistics menu 8-15
 Hold display 2-7
 Hold Off 8-21
 key 2-3
 specification 11-9
 used as filter 3-5
 Hold-Off
 Checking 9-16
 HOME-key 8-9
 HP Laserjet 8-7
 Hysteresis 3-8,4-16
 Hysteresis Window 11-5
- I**
- IBCONF 8-5
 Identification 1-9
 Impedance 2-4,8-18
 indication 2-9
 Increment setup 8-25
 Input
 selection 4-3
 Input A 8-18
 connector 2-7
 keys 2-2
 specification 11-5
 Input B 8-18
 connector 2-7
 delay line 4-22
 specification 11-5
 Input C
 connector 2-7
 specification 11-7
 Input channel
 select via Aux-codes 7-12
 Input E
 specification 11-7
 Input impedance 2-4
 Instability 6-6
 Installation 8-3 - 8-4
- Interface 8-6
 Interference 3-7
 Internal Reference output
 Checking 9-12
 Interpolators
 on/off 7-14
 Interrupt 8-5
 IO address 8-5
- J**
- Jitter 6-6 - 6-7,8-28
 Jitter measurements 8-23
- K**
- Keyboard
 Test 9-4
- L**
- Laser printers 8-7
 Laserjet 8-7
 Lithium battery
 SEE battery
 Local 2-2
 Long time instability 6-6
 Low-pass Filter 8-18,8-21
 digital 3-5
- M**
- Maintenance
 backup battery 10-4
 fan 10-4
 Mantissa 2-9
 Manual
 arming 5-9
 Manual scale 8-12
 Manual Totalizing 8-16
 Manual trigger levels 3-3
 Mathematics
 and Statistics together 6-6
 constants 6-3
 for display offset 5-5
 function 6-3
 specification 11-10
 Matrix printers 8-7

Max 11-10
 Statistical 2-8
Maximum 8-22
Mean 6-4,8-22,11-10
 Statistical 2-8
Measurement
 end 5-6
 free-running 5-26
 rate 5-6
 start. 5-6
 timing 5-6 - 5-13
Measurement rate 6-5
Measurement readout 8-16
measurement speed 8-17
Measurement start control
 SEE Start Arming
Measurement stop control
 SEE Stop Arming
Measurement uncertainties . . 11-2,11-12
Measuring function 8-16
Measuring Functions 7-12
 Checking. 9-15
Measuring Parameters 7-14
Measuring speed 4-12,5-7,6-5,8-17,8-24
Measuring time 2-7,5-6,8-17
 influence by prescaling 4-12
 setting 5-2
 specification 11-11
Memory
 specifications 11-11
Menu 2-3
 with more functions 7-2 - 7-16
Menu Bar 8-8 - 8-9
Menu Tree 8-11
Min. 11-10
 Statistical 2-8
Minimum 8-22
Minimum number of samples 8-17
Modulating frequency 8-30
Modulating frequency AM 4-10
Modulation cycles 8-28
Modulation detection 8-30
Modulations 8-17
Moving average. 8-36
Moving the cursors 8-9
Multiple block. 8-23

N

National/Philips interface card 8-5
No Bus 12-2
No data 12-2
No Prescaler 12-2
No Save. 12-2
No signal 12-2
No trig
 display message 4-12
Noise 3-7
 suppression filter 3-5
Nulling 6-2
Number of average 8-36
Number of bins 8-28
Numerical input fields 8-9

O

Orientation 1-11
Oscillators
 calibration 10-2
Output G
 specification 11-8
Output H
 specification 11-8
Overdrive 4-16
Overflow 5-5,12-2
Overshoot 8-18

P

Packing list 1-9
Period 4-4
 specification 11-3
 uncertainty 11-12
Phase 4-20 - 4-27
 inaccuracies 4-23
 ranges. 4-22
 uncertainty 11-2,11-13
Pop Up Windows 8-9
Power-On Test 9-3
Preparing a measurement. 8-16
Prescaling
 effect of. 4-12
Preset
 key 2-2
Primary channel 7-12

Print 8-39 - 8-40
 Print setting data 8-7
 Print the current graph 8-15
 Printer 8-7
 Printer settings 8-39
 Probe Comp View
 Output test 9-14
 Probe compensation
 output specification 11-8
 using 2-13 - 2-14
 Processing a measuring result 6-2
 Profiling 5-14,5-26
 transient 5-27
 VCO step response 5-27
 Program version 7-6
 Proprinter 8-7
 Pull-down Menu 8-8
 Pulse period 4-4
 Pulse rounding 4-16
 Pulse Width
 description 4-15
 minimum 11-5
 specification 11-3
 uncertainty 11-12

Q

QEMM 8-6
 Quick reference summary 8-11

R

Rack mount adapter
 installation 1-12
 Random Uncertainty 11-15,11-21
 Rate of measurement 5-6
 Ratio
 function 4-4
 specification 11-3
 uncertainty 11-2,11-12 - 11-13
 Recalibration
 intervals 10-2
 Recalling front panel settings 2-3
 Reciprocal counting 4-11
 Ref. oscillator 8-22
 Reference
 output specification 11-8
 Reference In

 SEE External Reference input
 Reference Oscillators
 Checking 9-10
 Reinitiate GPIB 8-7
 Reinstalling the Cover 1-13
 Repetitive sampling 8-35
 Repetitive sampling data 8-25
 Required Test Equipment
 Performance Check 9-2
 Reset
 totalizing 4-17
 Resolution 8-17
 Checking 9-11
 Retrieve 8-37
 Rise/fall time 4-15
 Auto trigger levels 3-3
 uncertainty 11-12
 RMS-jitter read-out 8-28
 Root Allan Variance 8-28

S

Sample frequency 8-34
 Sample size 8-22
 statistics 7-7
 time Interval average 6-2,7-6
 Sample-hold 4-11
 Save 8-37
 Saving front panel settings 2-3
 Scale 8-15
 Scale 8-12
 Screen 8-7
 Scroll lock 8-10
 Secondary channel 7-12
 Select functions 8-9
 Select menus 8-9
 Self-test 7-7,9-3 - 9-4
 Sensitivity 4-16,11-5
 Checking 9-7
 SET A and SET B 3-3
 Setting files 8-37
 Setting up the timer/counter . 8-16 - 8-22
 Setup time
 for arming 5-13
 Short term jitter 8-28
 Shortcut keys 8-15
 Signal readout 8-18
 Single 4-12,5-6,6-2,8-17
 Single block 8-23

Single-shot phenomena 5-9
Slope 2-4,8-18
 on E input 7-14
Smooth the Measurement data 8-15
Smoothing menu 8-15,8-36
Speed 5-7,8-17
 arming 5-13
 of auto trigger 3-3
 of measurement 4-12
Split auto 7-15
Stand-by 2-2
Standard deviation 6-4,8-22
 Statistical 2-8
Standard Oscillator
 Checking 9-10
Start
 arming 5-3,5-9,7-8
 manual totalizing 2-6
 of a measurement 5-6 - 5-7
 totalizing 4-17
Startup options 8-4
Statistics 6-4 - 6-8,8-21,8-28 - 8-29
 and Mathematics together 6-6
 sample size 7-7
 specification 11-10
Statistics menu 8-28
Std Dev. 11-10
Stop
 arming 5-3,5-9,7-8
 manual totalizing 2-6
 of measurement 5-7
 totalizing 4-17
Store a setting 2-3
Supply voltage
 setting 1-10
Support
 fold-down 1-12
Swap A-B 2-4
Synchronization of a measurement . 4-11
Synchronize the measurement 8-19
Synchronization delay
 arming 5-11
Systematic Error 11-16
Systematic errors
 in Phase measurements 4-24

T

T-piece-connection 8-19
Test programs
 SEE Self test
Time
 set the measuring 5-2
 period 4-4
 to set up arming 5-13
Time between measurements. 8-17
Time Delay 11-9
Time interval 4-14 - 4-16
 sample size for average 6-2,7-6
 specification 11-3
 uncertainty 11-12
Time jitter 8-26
Time Out 11-19
Time scale 8-25
Time step 8-25
Time-out 8-7
Timebase
 calibration 10-2
Timebase Error 11-17
Timebase reference 8-22
Timeout 8-6
 auto 4-11
 fixed 4-11
 manual 4-11
 set 7-6
TIMEVIEW.CFG 8-4
Title Bar 8-9
Totalize 4-17 - 4-19
 A gated by B accumulated during a
 preset time 4-19
 A started/stopped by B single . . . 4-19
 A-B Manual 4-17
 TOTAlize A gated by B single . . . 4-19
Totalized Timed 8-16
Totalizing
 reset 4-17
 start 4-17
 stop 4-17
Touch-hold
 SEE Sample-hold
Transient profiling 5-27
Trigger Controls
 Checking 9-9
Trigger error 3-9
Trigger Hold Off 11-9

Trigger Hold Off 3-5
 Trigger hysteresis 3-8
 Trigger indicators
 Checking 9-9
 function 3-4
 Trigger level 8-18
 Auto 3-3,3-5 - 3-6
 Converting Auto to Manual 3-4
 how to use 3-9
 Manual 3-3
 output 2-12
 output specification 11-8
 range 3-4
 setting speed 3-3
 Trigger Level
 Output test 9-14
 Trigger Settings 3-4,7-15

U

Underflow 12-2

V

Variable hysteresis 3-4,7-5
 auto trigger levels 3-4
 specifications 11-6
 VCO 8-25
 step response profiling 5-27
 Verify input impedance 8-18
 View 8-11
 View Active Captured data 8-15
 View analyzed data 8-11
 View captured data 8-11
 View Distribution (Statistics) 8-15
 View FFT 8-15
 View Smoothing 8-15
 VMAX/VMIN
 Checking 9-7
 Volt max/min 8-16
 Checking 9-7
 Voltage
 Check 9-7
 function 4-28
 gated measurements 7-14
 high speed mode 7-14
 specification 11-2,11-5
 Voltage, supply 1-10

W

Warm-up Time 11-18
 Warning statements 1-7
 Windows 8-6

X

X MAX 6-4
 X MIN 6-4
 X-scale 8-12
 X0 2-8,6-4
 Xn-1 6-3

Y

Y-axis 8-26
 Y-scale 8-35

Z

Zoom in 8-15,8-28
 Zoom in 8-12
 Zoom Out 8-15

This page is intentionally left blank.

Chapter 14

Service

Sales and Service office

For service information, contact your Fluke service center. To locate an authorized service center, visit us on the World Wide Web: <http://www.fluke.com>, or call Fluke using any of the phone numbers listed below:

+1-888-993-5853 in U.S.A and Canada

+31-402-687-200 in Europe

+1-425-356-5500 from other countries